



Tetra4D Enrich

Version 2017 SP1

User Guide

Document version: V2.1

Table of Contents

Chapter 1: Getting started.....	4
Help	4
Installation and activation	4
Installation of Acrobat XI Pro and Acrobat Pro DC	4
System Requirements	4
Installation of Tetra4D Enrich.....	5
Running Tetra4D Enrich.....	5
License activation	5
Chapter 2: Tetra4D Enrich overview.....	6
Tetra4D Enrich for Acrobat XI Pro	6
Tetra4D Enrich for Acrobat Pro DC.....	7
Tetra4D Enrich for Acrobat Pro DC.....	8
Chapter 3: Tetra4D Enrich features.....	9
Tetra4D Enrich Tools Menu	9
3D	10
3D > Add 3D	10
3D > Add 3D attributes	11
3D > Replace 3D.....	17
Widgets.....	19
Widget > Add Carousel	19
Widget > Add part list (flat)	24
Widget > Add part list (hierarchical).....	25
Widget > Add table from CSV	26
Widget > Add table from clipboard	27
Widget > Add Search	36
Actions.....	45
Overview.....	45
Actions > On Button.....	46
Actions > On 3D view	48
Actions > On 3D part.....	50

Actions > On table row	51
Description of actions.....	53
Activate View	53
Previous View / Next View.....	54
Render Mode	55
Node Color.....	56
Node Visibility.....	57
Set Text in Field	58
Rotate / Pan / Zoon	60
Fit visible.....	61
Fit selected	62
Full Screen Mode	63
Edit	64
Edit 3D	64
Edit Widget: Carousel of views	71
Edit Widget: Table	73
Edit Widget: Search	75
Edit Actions.....	77
Edit Populate method for text fields.....	83
Acrobat tools	84
Add button.....	85
Add text field	86
Edit object.....	87
Set populate method for text fields.....	88
Populate text fields from XML	93

Chapter 1: Getting started

Tetra4D Enrich is a plug-in for Adobe® Acrobat® Pro which allows you to create rich, interactive PDF documents from a wide range of 3D CAD files or from existing PDFs.

The Tetra4D Enrich product includes the Tetra4D Converter plug-in, which provides the ability to read native 3D CAD files and additional industry-standard 3D file formats.

Before you begin working with Tetra4D Enrich™, please take a few moments to read an overview of the license activation process and about the many resources available to you. You have access to instructional videos, templates, user communities, seminars, tutorials, RSS feeds, and much more at <http://www.tetra4d.com>.

Help

As part of your purchase, you are eligible for support of your installation of Tetra4D Enrich via a maintenance contract. Your maintenance contract also gives you access to new versions of Tetra4D Enrich as they are released. If you have questions about the status of your maintenance contract, give us a shout.

For help with this and any other general support need that you have, please submit a support request by going to our [customer portal](#).

For support specific to Adobe Acrobat, please visit the Adobe Support website at: <http://helpx.adobe.com/support.html>.

Installation and activation

Installation of Acrobat XI Pro and Acrobat Pro DC

Tetra4D Enrich has been developed as a plug-in for Adobe Acrobat Pro and supports versions XI and DC. As such, Acrobat XI Pro or Pro DC is required to be installed for Tetra4D Enrich to function.

A free trial of Acrobat Pro DC can be downloaded at:

https://www.acrobat.com/en_us/free-trial-download.html

Please refer <https://helpx.adobe.com/acrobat.html> for detailed instructions and troubleshooting related to Acrobat Pro DC.

System Requirements

Please refer to the Tetra4D Enrich installation guide by going to <http://tetra4d.com/documentation> or by accessing your [customer portal](#).

Installation of Tetra4D Enrich

Please refer to the Tetra4D Enrich installation guide by going to <http://tetra4d.com/documentation> or by accessing your [customer portal](#).

Running Tetra4D Enrich

To run Tetra4D Enrich, please go to your start menu and launch Acrobat Pro. When you first launch Acrobat Pro after installing Tetra4D Enrich, you will see the following dialog box until your license has been activated.

Tetra4D Enrich starts automatically in a trial mode, with a 28 day duration.



- Select the **Buy Now** button to go to the Tetra4D web store to purchase licenses of the Tetra4D Enrich.
- Select the **Continue Trial** button to run in trial mode. The Tetra4D Enrich will run in trial mode for up to 28 days after installation.
- You will receive a serial number in an email from tetra4d.com when you purchase Tetra4D Enrich. To activate your license, select the **I already have a serial number** button and then follow the license activation instructions.

If you are unsure what your license status is or just need help in general, please submit a support request by going to your [customer portal](#).

License activation

Please refer to the Tetra4D Enrich installation guide by going to <http://tetra4d.com/documentation> or by accessing your [customer portal](#).

Chapter 2: Tetra4D Enrich overview

Tetra4D Enrich allows you to create rich PDFs from supported 3D and CAD file formats, to consolidate this 3D information with other types of information (meta-data...), and to add into the PDF document advanced objects in order to ease the access to the product information.

Note: This user manual is based on the Acrobat Pro DC version of Tetra4D Enrich. All screen shots have been made using Acrobat Pro DC.

Tetra4D Enrich for Acrobat XI Pro

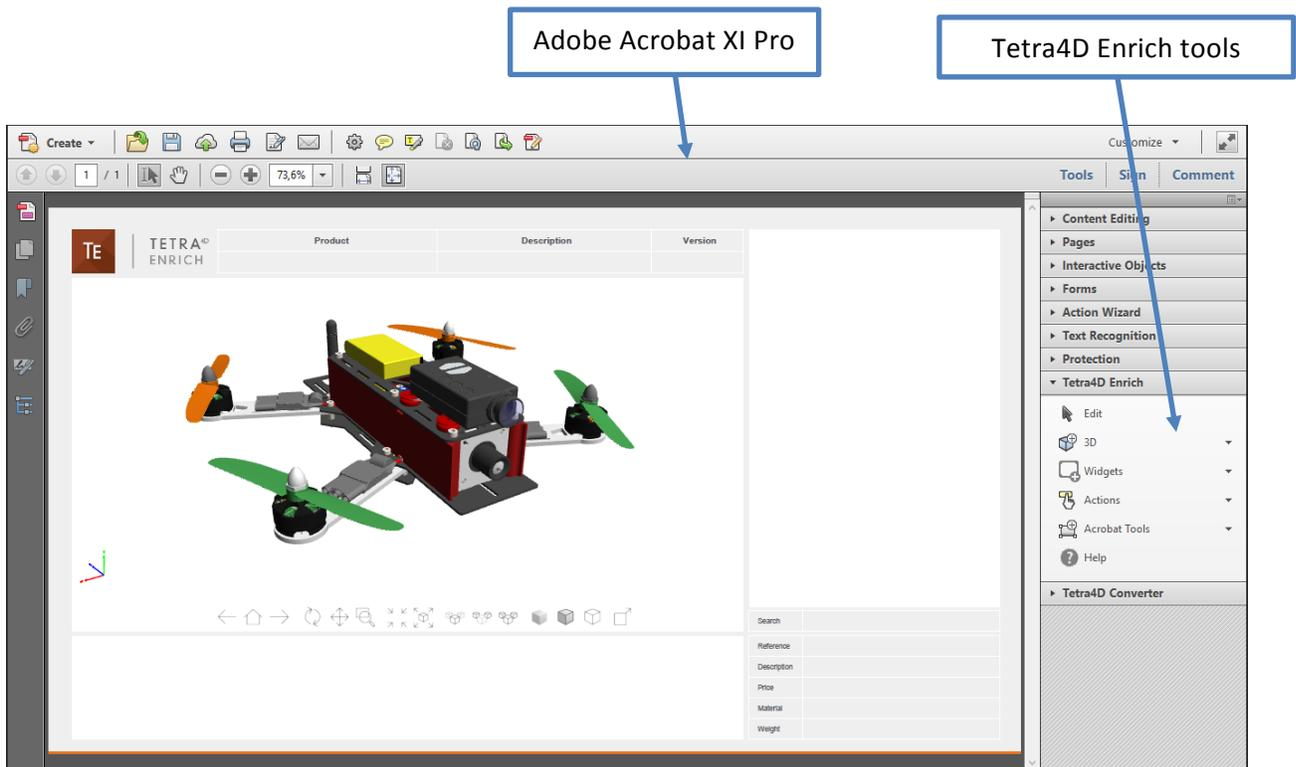

Tetra4D Enrich plug-in in Acrobat XI Pro

Tetra4D Enrich for Acrobat Pro DC

Adobe Acrobat Pro DC introduces a new user interface and Tetra4D Enrich fully integrates with this enhancement. In the new workspace, you can find the Tetra4D Enrich tools in the following area:

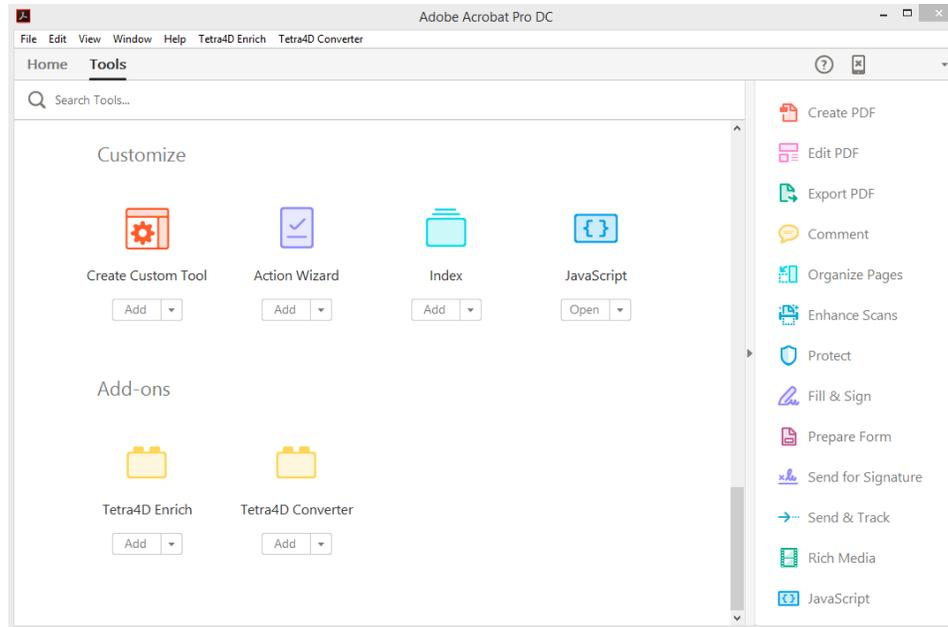

Note that Tetra4D Enrich product installs 2 plug-ins:

- Tetra4D Enrich
- Tetra4D Converter

The button below the Tetra4D Enrich and Tetra4D Converter icons have a few different options:



Open: Open the Tetra4D Enrich tools.

Add / Add Shortcut: Add a Tetra4D Enrich shortcut in the right pane.

Remove Shortcut: Remove the existing shortcut from the right pane.

For more information about the Acrobat Pro DC user interface, please refer to:

<https://helpx.adobe.com/acrobat/using/workspace-basics.html>

Tetra4D Enrich for Acrobat Pro DC

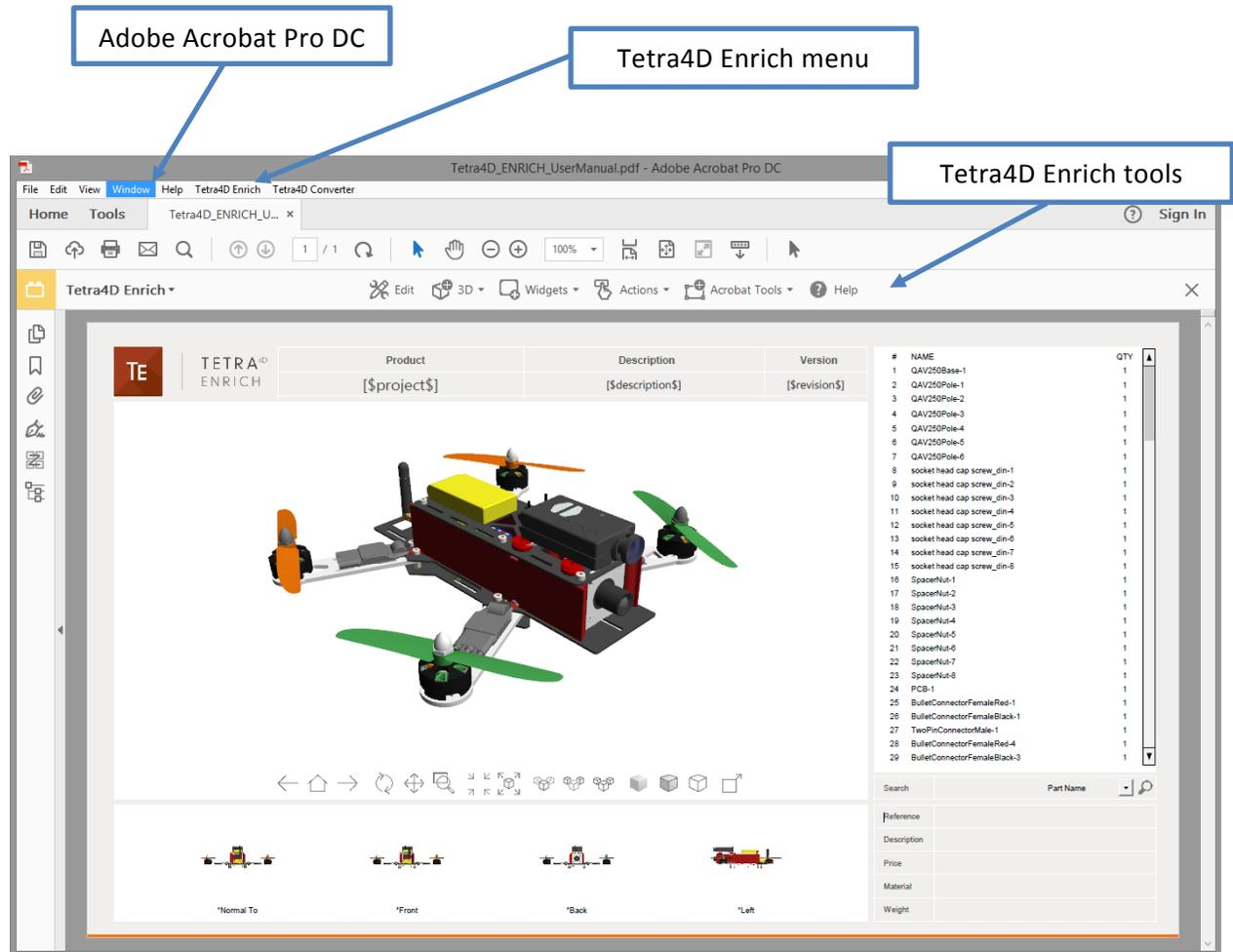

Tetra4D Enrich plug-in in Acrobat Pro DC

Chapter 3: Tetra4D Enrich features

Tetra4D Enrich Tools Menu

- Acrobat XI Pro

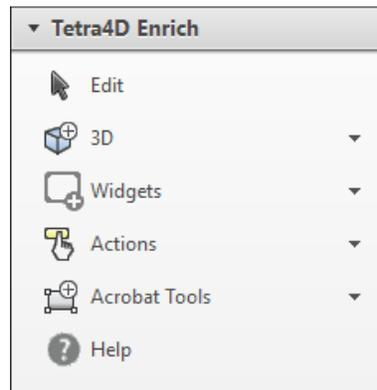

- Acrobat Pro DC



The Tetra4D Enrich top menu provides access to the different features of the product.

This section will explain how to use each of these features.

Remark:

If no document is open, the toolbar is greyed out. The features become accessible when a PDF document/template is open.

3D

"3D" refers to 3D annotations. A 3D annotation is a subwindow in the PDF document which displays a 3D model.

3D > Add 3D

The "Add 3D" function allows 3D CAD data to be converted and inserted into a PDF Document. The 3D data will be imported as an annotation in its own subwindow.

Adding 3D is done in the following way:

1. Within the Tetra4D Enrich toolbar, choose 3D > Add 3D.
2. Define the position and the size of the 3D annotation by dragging a rectangle.
3. Select the 3D source file containing the model you want to load in the "Open File" dialog.
4. Define the conversion settings in the "3D Conversion Settings" dialog.
5. Press the OK button to confirm.

Remark:

3D models are read by Tetra4D Converter, which is part of the Tetra4D Enrich product. For more information about the 3D conversion settings, please refer to the [Tetra4D Converter](#) user manual.

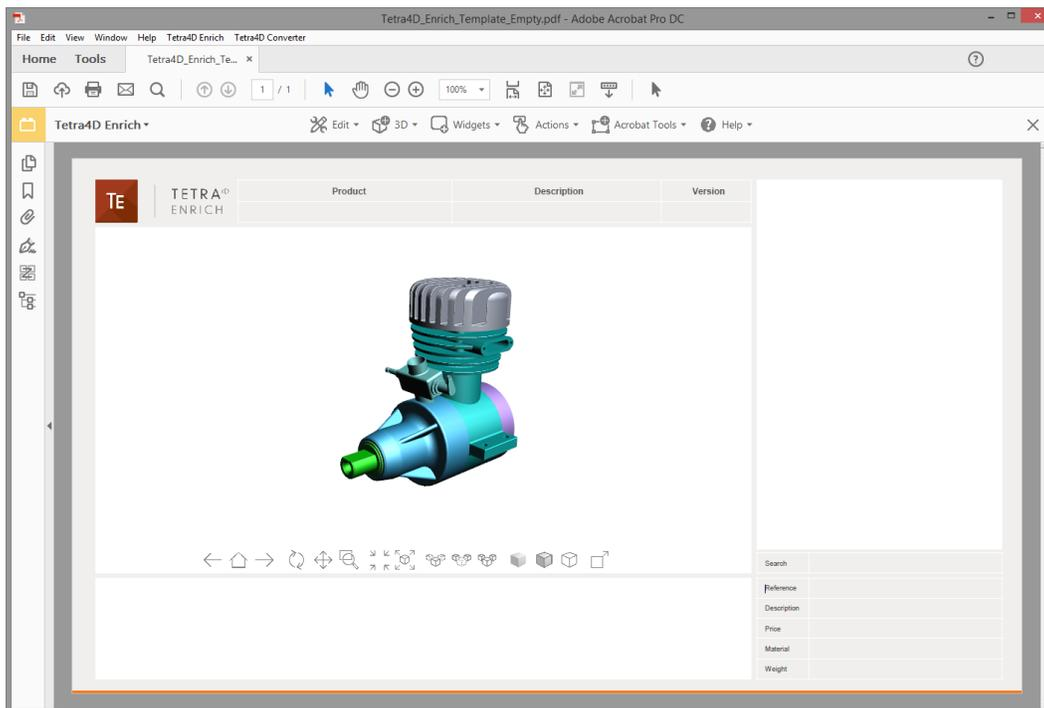

3D annotation in the PDF document

3D > Add 3D attributes

The Add 3D attributes function allows you to import attributes (meta-data) from an external source, such as for example a PDM (Product Data Management), a PLM (Product Lifecycle Management), or an ERP (Enterprise Resource Planning) application.

Tetra4D Enrich will correlate these attributes with the 3D parts that are currently in the PDF document. They can then be accessed in a [Table](#) or displayed in text fields by defining [Actions](#), just like the attributes that have been read from the native CAD data.

Remark:

The attributes are imported from XML files. The mapping between the attributes and the 3D parts must be defined in the XML file because it is performed at the time of import. See below the definition of the [XML format](#) and the mapping capabilities.

1. Within the Tetra4D Enrich toolbar, choose 3D > Add 3D attributes.
2. Select the XML file containing the attributes you want to import in the “XML File” dialog.
3. Check the result of the import in the dialog that pops-up.

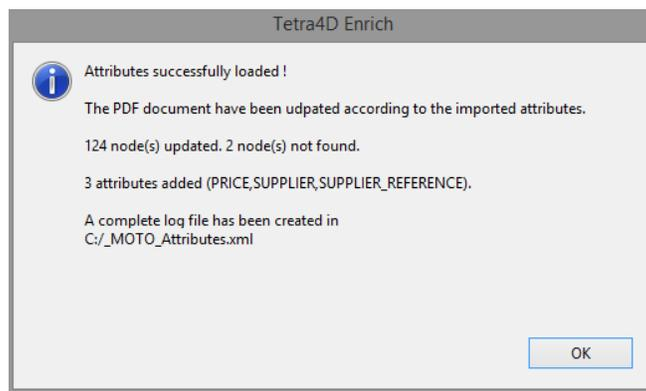

Dialog showing the result of the import of attributes operation

Note: the dialog presents several pieces of information:

- Number of nodes (parts) to which attributes have been added.
- Number of nodes (parts) that haven't been found (mapping wasn't possible).
- Names of the attributes that have been added.
- A Log file is generated in the folder where the XML file was read. It provides the user with a detailed list of updated nodes, according to the mapping key and value, and a list of nodes that haven't been found.

Remark:

Imported attributes are added to the parts, but can't be accessed in the document data tree like the attributes that have been read from the native CAD data.

Imported attributes can only be accessed using the [Table](#) or the [Actions](#) features of Tetra4D Enrich.

Format of the XML file

The XML file must contain all the required information to define new attributes and to add these attributes to the 3D data that is in the 3D annotation.

There are two different mapping methods:

- Based on the value of an attribute of the part.
- Based on the name of the part in the 3D annotation.

XML format, with a mapping based on the value of an attribute

- Example of a file:

```
<attributes>
  <ATTRIBUTE key="AttribName" attribute_value="AttribValuePart1">
    <NEW_ATTRIB name="NewAttribName1" value="NewAttribName_Val1_Part1" />
    <NEW_ATTRIB name="NewAttribName2" value="NewAttribName_Val2_Part1" />
  </ATTRIBUTE>
  <ATTRIBUTE key="AttribName" attribute_value="AttribValuePart2">
    <NEW_ATTRIB name="NewAttribName1" value="NewAttribName_Val1_Part2" />
    <NEW_ATTRIB name="NewAttribName2" value="NewAttribName_Val2_Part2" />
  </ATTRIBUTE>
</attributes>
```

- Key for the mapping:

```
<ATTRIBUTE key="AttribName" attribute_value="AttribValuePart1">
```

AttribName: Must be an existing attribute in the CAD file

AttribValuePart1: Value of the attribute of the part

- New attribute definition:

```
<NEW_ATTRIB name="NewAttribName1" value="NewAttribName_Val1_Part1" />
```

NewAttribName1: Name of the new attribute

NewAttribName_Val1_Part1: Value of the new attribute for the part

- Example:
 - CAD model in the PDF document

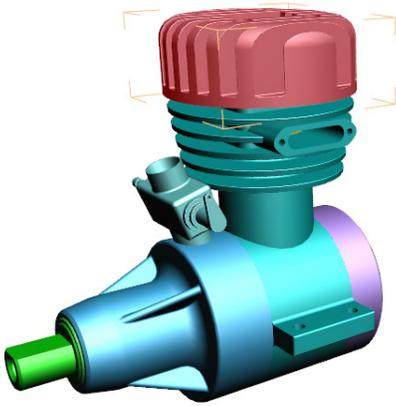

InstanceName	HOUSING TOP.1
ItemNumber	H1212556
Material	Steel
PartNumber	HOUSING TOP
Source	Unknown

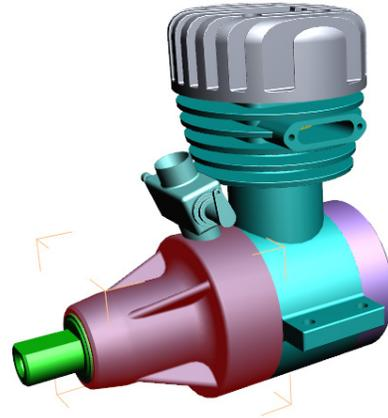

InstanceName	HOUSING FRONT.1
ItemNumber	H4114567
Material	Aluminium
PartNumber	HOUSING FRONT
Source	Unknown

Native CAD attributes for the 2 selected parts

- Imported XML file to add attributes

```

<attributes>
  <ATTRIBUTE key="ItemNumber" attribute_value="H1212556">
    <NEW_ATTRIB name="SUPPLIER" value="Supplier A" />
    <NEW_ATTRIB name="SUPPLIER_REFERENCE" value="RefA01" />
  </ATTRIBUTE>
  <ATTRIBUTE key="ItemNumber" attribute_value="H4114567">
    <NEW_ATTRIB name="SUPPLIER" value="Supplier B" />
    <NEW_ATTRIB name="SUPPLIER_REFERENCE" value="RefB01" />
  </ATTRIBUTE>
</attributes>

```

- mapping is performed using the ItemNumber attribute
- 2 attributes are added to the 3D parts: SUPPLIER and SUPPLIER_REFERENCE

XML format, with a mapping based on name of the part in the 3D annotation

- Example of a file:

```
<attributes>
  <NAME key="PartName1">
    <NEW_ATTRIB name="NewAttribName1" value="NewAttribName_Val1_Part1"/>
    <NEW_ATTRIB name="NewAttribName2" value="NewAttribName_Val2_Part1"/>
  </NAME>
  <NAME key="PartName2">
    <NEW_ATTRIB name="NewAttribName1" value="NewAttribName_Val1_Part2"/>
    <NEW_ATTRIB name="NewAttribName2" value="NewAttribName_Val2_Part2"/>
  </NAME>
</attributes>
```

- Key for the mapping:

```
<NAME key="PartName1">
  PartName1: Name of the part as shown in the data tree
```

- New attribute definition:

```
<NEW_ATTRIB name="NewAttribName1" value="NewAttribName_Val1_Part1"/>
  NewAttribName1: Name of the new attribute
  NewAttribName_Val1_Part1: Value of the new attribute for the part
```

- Example:
 - CAD model in the PDF document

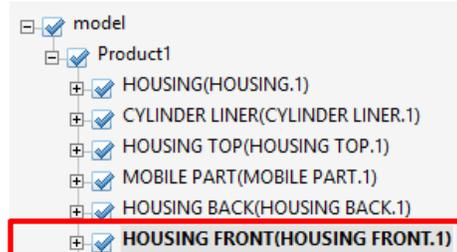
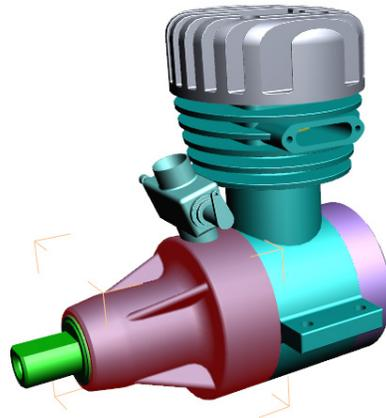
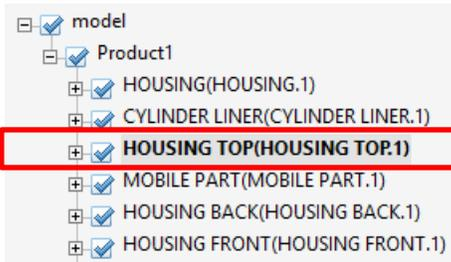
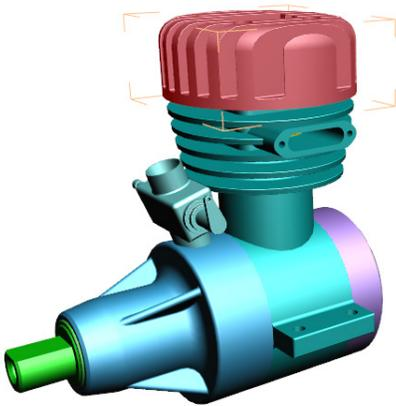

Name of the parts in the data tree

- Imported XML file to add attributes

```
<attributes>
  <NAME key="HOUSING TOP (HOUSING TOP.1)">
    <NEW_ATTRIB name="SUPPLIER" value="Supplier A"/>
    <NEW_ATTRIB name="SUPPLIER_REFERENCE" value="RefA01"/>
  </NAME>
  <NAME key="HOUSING FRONT (HOUSING FRONT.1)">
    <NEW_ATTRIB name="SUPPLIER" value="Supplier B"/>
    <NEW_ATTRIB name="SUPPLIER_REFERENCE" value="RefB01"/>
  </NAME>
</attributes>
```

- Mapping is performed using names of the parts (as shown in the data tree)
- 2 attributes are added to the 3D parts: SUPPLIER and SUPPLIER_REFERENCE

Setting unselectable parts (in the 3D annotation)

The Add 3D attributes function allows you to also define some behavior settings linked to the parts. It is possible to disable the selection of parts in the 3D annotation by adding a specific attribute and its value to the parts that must be set as unselectable.

The parts that are set as “unselectable” won’t be selectable in the 3D annotation, but will remain selectable in a table (if table is linked to the 3D annotation).

As a default, all the parts are selectable.

- Attribute name: IsSelectable
- Value: False

Example

```
<attributes>
  <NAME key="PartName1">
    <NEW_ATTRIB name="NewAttribName1" value="NewAttribName_Val1_Part1"/>
    <NEW_ATTRIB name="NewAttribName2" value="NewAttribName_Val2_Part1"/>
    <NEW_ATTRIB name="IsSelectable" value="False" />
  </NAME>
</attributes>
```

3D > Replace 3D

This function enables you to replace an existing 3D annotation in a PDF document with a new set of 3D CAD data.

If this PDF document contains a [Carousel of views](#) and a [Table](#), these two items will be updated accordingly to the new 3D CAD data.

If the document contains [actions](#), the “generic” actions will also be updated.

Remark:

Generic actions are those that can be retained with the new 3D model because they are not linked to something particular in the original 3D data, or because the nature of the action is also applicable for any 3D model. For example, the activation of the next view, the activation of the Solid rendering mode would be generic actions.

Conversely, an action linked to a button that would change the color of a particular part of the 3D model is not a generic one.

Furthermore, the replace 3D feature does not support the "[Add 3D Attributes](#)" function. If you need to add external attributes (that are "connected" to the 3D model), you must first execute the replace the 3D feature to update the PDF document (3D annotation, table, Carousel of views, generic actions), and then import the 3D attributes using the [Add 3D attributes](#) function.

In such a case, it could be required to edit the table after using the Add 3D attributes function in order to fill some existing columns with the newly imported attributes.

1. Within the Tetra4D Enrich toolbar, choose 3D > Replace 3D.

Note: *If the active page of the 3D PDF document contains several 3D annotations, make sure first to activate the 3D annotation that will be replaced (the Replace 3D feature automatically selects the active 3D annotation).*

To activate a 3D annotation, just place the mouse cursor inside it and make a change in the viewing orientation for example.

2. Select the 3D source file containing the model you want to load in the “Open File” dialog.
3. Define the conversion settings in the “3D Conversion Settings” dialog.
4. Press the OK button to confirm.

Remark:

3D models are read by Tetra4D Converter, which is part of Tetra4D Enrich product. For more information about the 3D Conversion settings, please refer to the [Tetra4D Converter](#) user manual.

- Example:

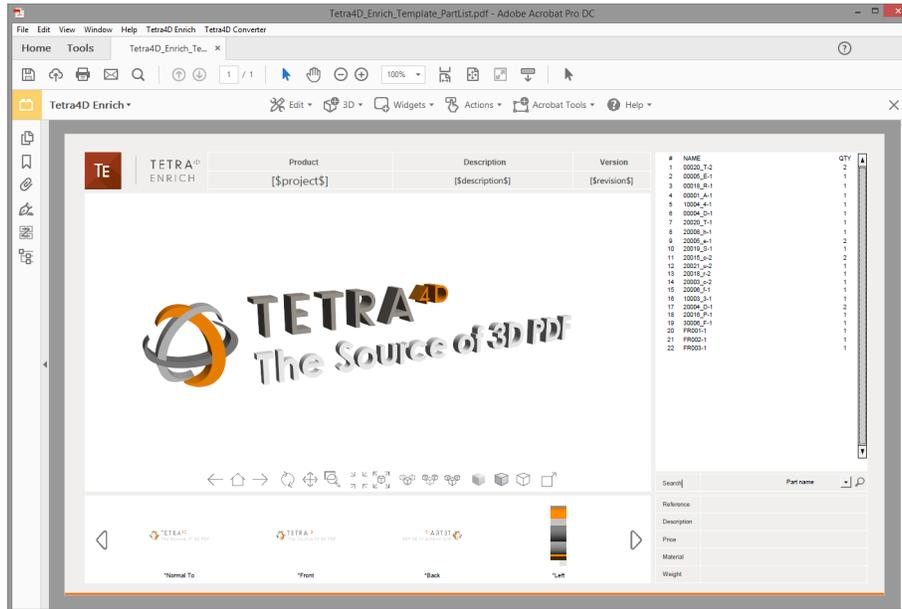

Template document created using Tetra4D Enrich

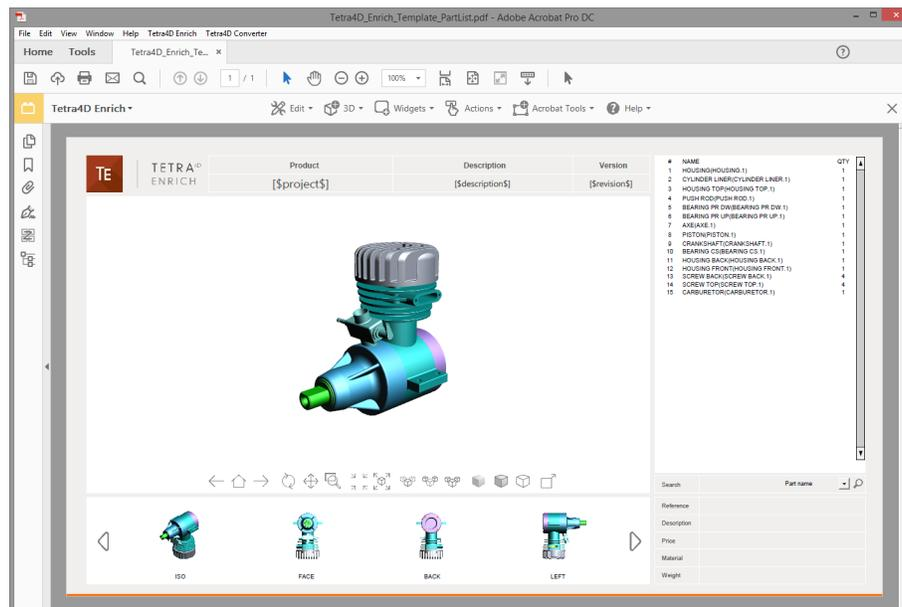

Populated template with new 3D CAD data (after Replace 3D operation)

Widgets

Widget > Add Carousel

The carousel of views is a widget that can be inserted in the PDF document to list the 3D views. The views are presented as image thumbnails, allowing the user to easily browse and activate one. To activate a view, click on its thumbnail. The 3D annotation will then transition to that view.

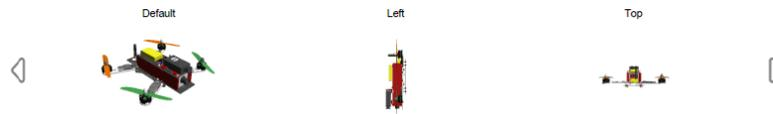

A carousel of views

Creation of a Carousel

1. Within the Tetra4D Enrich toolbar, choose Widget > Add Carousel.
2. Drag a rectangle to define the location and the size of the carousel.
The rectangle cannot overlap with other Tetra4D Enrich items.
Once the rectangle is defined, the Carousel editor panel appears on the right.
3. Use the frame controllers to resize the carousel, if needed.
4. Adjust the carousel properties to your specifications by selecting the commands in the Edit panel in the right.
5. Click on the green check button “Validate the carousel modifications” icon to save the carousel, or
6. Click on the red “X” button “Cancel the carousel modifications” icon to discard the changes.

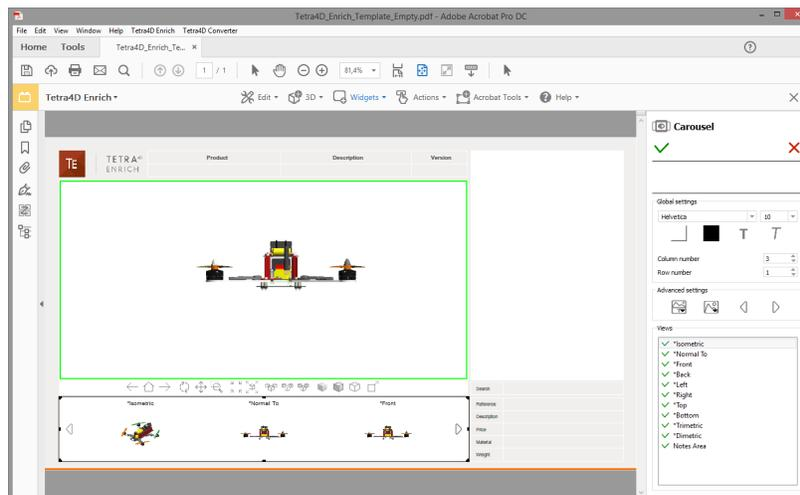

Creation of a Carousel of views

Remark:

The carousel can be defined either as a horizontal or vertical frame. By default, the carousel shows three views and two buttons that allow the user to scroll the views. The buttons will be automatically repositioned depending on the orientation of the carousel.

Definition of the Carousel layout

The Editor panel offers several settings to define the layout of the Carousel.

Hover your mouse over any of the buttons to see the specific command.

- **Global settings:** Defines the number of rows and columns, the colors, and the font information.
- **Advanced settings:** Defines the icons used for side buttons and regenerates the thumbnails of the views.
- **Views:** Defines the views that are listed in the Carousel, and their order.

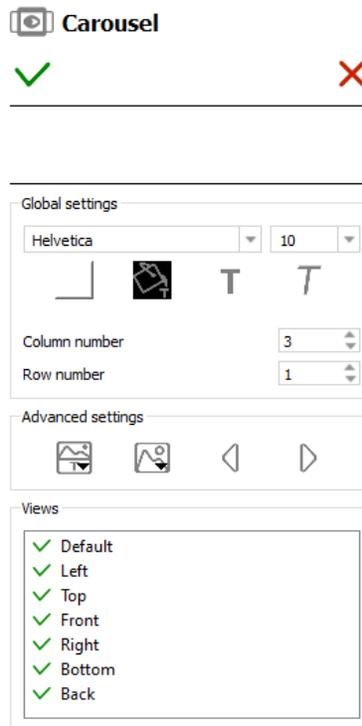

Edit panel for Carousel of Views

Global settings subpanel

- **Font settings:** Defines the font and the font size for the names of views displayed in the thumbnails.
- **Font color, Bold, Italic:** Applies to the names of views displayed in the thumbnails.
-  **Background color:** Defines the background color of the carousel.
Note: The background color applies to the carousel only and doesn't affect the thumbnails themselves.
- **Column number:** Defines the number of columns of the carousel. The value is limited to a range of 1 to 10
- **Row number:** Defines the number of rows of the carousel. The value is limited to a range of 1 to 10.

Of particular importance are the "Column number" and "Row number" options. Make sure the number of rows and columns makes sense for the space that the carousel is occupying. For example, you normally wouldn't want a horizontally oriented carousel to have a single column with multiple rows.

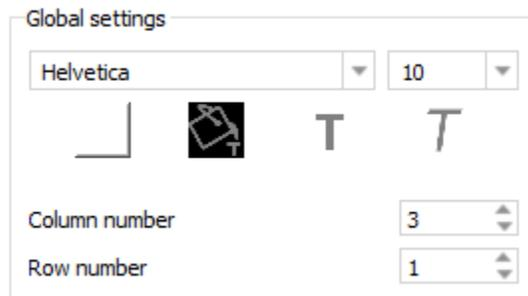

Global settings area of the Carousel edit panel

Advanced settings subpanel



Advanced settings area of the Carousel edit panel

-  **Display/hide poster/text and change text position**
 - **Display text:** Displays or hides the view titles in the carousel
 - **Display poster:** Displays or hides the screenshot (poster) images in the carousel
 - **Change text position:** Repositions the view titles. The options are above or below the poster images.
-  **Change or reload posters**
 - **Change poster:** Opens a dialog which allows to select a new poster image from the file system.

This option applies to the thumbnail currently selected in the Carousel.
 - **Update poster:** Regenerates the view poster image. This action may be required if the view has been modified by the user and the poster needs to be updated to reflect the modification.

This option applies to the thumbnail currently selected in the Carousel.
 - **Update all posters:** Regenerates all view poster images. This action may be required if some views have been modified by the user and the posters need to be updated to reflect the modifications.
-   **Change the previous / next button icon**
 - The left and right arrows icons that appear in the carousel of views can be changed by selecting a new image from the file system.

Views subpanel

If you wish to exclude certain views from the view carousel, simply uncheck the view name in the "Views" area of the sidebar. The green check will be replaced with a red X indicating the view is to be excluded.

Views can also be reordered. Click on one view in the list and drag it to another place. Reordering the views only affects the carousel presentation - it has no effect on the PDF views.

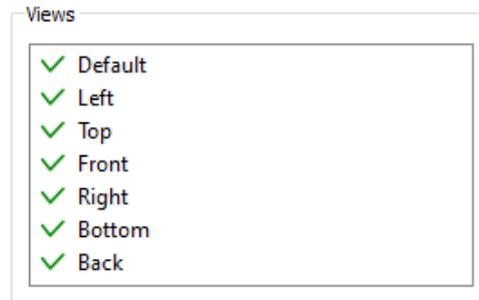

Views settings area of the Carousel editor panel

- **Deactivation of a view:** Click on an active view (marked by a green check) in the list.
- **Activation of a view:** Click on a deactivated view (marked by a red cross) in the list.
- **Reordering views:** Click the view to be reordered while maintaining the mouse button pressed, and drag the view to the new position in the list. Make sure the view is not deactivated.

Widget > Add part list (flat)

The “Add part list (flat)” menu allows you to create a table in the PDF document. The flat part list is generated by parsing the model structure of the 3D parts.

Creation of a part list (flat)

This table is generated from the 3D data in the PDF document.

1. Within the Tetra4D Enrich toolbar, choose Widget > Add part list (flat).
2. Drag a rectangle to define the location and the size of the table.
3. Use the frame controllers to resize the table.
4. Drag the table border to reposition the table if required.
5. Adjust the table properties to your specifications by selecting the options in the Edit panel in the right.

Note: Refer to [Definition of the part list and table settings](#) to have detailed explanations about how to customize the table presentation.

6. Click on the green check “Validate the table modifications” icon to save the carousel, or
7. Click on the red “X” “Cancel the table modifications” icon to discard the changes.

The flat part lists are generated according to the 3D model currently present in the PDF document.

The flat part list only lists the components of the assembly and the total number of these components, independent of their position in the assembly hierarchy.

#	NAME	QTY
1	HOUSING(HOUSING.1)	1
2	CYLINDER LINER(CYLINDER LINER.1)	1
3	HOUSING TOP(HOUSING TOP.1)	1
4	PUSH ROD(PUSH ROD.1)	1
5	BEARING PR DW(BEARING PR DW.1)	1
6	BEARING PR UP(BEARING PR UP.1)	1
7	AXE(AXE.1)	1
8	PISTON(PISTON.1)	1
9	CRANKSHAFT(CRANKSHAFT.1)	1
10	BEARING CS(BEARING CS.1)	1
11	HOUSING BACK(HOUSING BACK.1)	1
12	HOUSING FRONT(HOUSING FRONT.1)	1
13	SCREW BACK(SCREW BACK.1)	4
14	SCREW TOP(SCREW TOP.1)	4
15	CARBURETOR(CARBURETOR.1)	1

A “flat part list” table

Widget > Add part list (hierarchical)

The “Add part list (hierarchical)” menu allows you to create a table in the PDF document. The hierarchical part list is generated by parsing the model structure of the 3D parts.

Creation of a part list (hierarchical)

This table is generated from the 3D data in the PDF document.

1. Within the Tetra4D Enrich toolbar, choose Widget > Add part list (hierarchical).
2. Drag a rectangle to define the location and the size of the table.
3. Use the frame controllers to resize the table.
4. Drag the table border to reposition the table if required.
5. Adjust the table properties to your specifications by selecting the options in the Edit panel in the right.

Note: Refer to [Definition of the part list and table settings](#) to have detailed explanations about how to customize the table presentation.

6. Click on the green check “Validate the table modifications” icon to save the table, or
7. Click on the red “X” “Cancel the table modifications” icon to discard the changes.

The hierarchical part lists are generated according to the 3D model currently present in the PDF document.

The hierarchical part list reflects the hierarchy of the 3D information. Sub-assemblies are shown with indented part names and the components quantities are calculated locally, at the hierarchical level where they are found.

#	NAME	QTY
1	HOUSING(HOUSING.1)	1
2	CYLINDER LINER(CYLINDER LINER.1)	1
3	HOUSING TOP(HOUSING TOP.1)	1
4	MOBILE PART(MOBILE PART.1)	1
4.1	PUSH ROD(PUSH ROD.1)	1
4.2	BEARING PR DW(BEARING PR DW.1)	1
4.3	BEARING PR UP(BEARING PR UP.1)	1
4.4	AXE(AXE.1)	1
4.5	PISTON(PISTON.1)	1
4.6	CRANKSHAFT(CRANKSHAFT.1)	1
4.7	BEARING CS(BEARING CS.1)	1
5	HOUSING BACK(HOUSING BACK.1)	1
6	HOUSING FRONT(HOUSING FRONT.1)	1
7	SCREW BACK(SCREW BACK.1)	4
8	SCREW TOP(SCREW TOP.1)	4
9	CARBURETOR(CARBURETOR.1)	1

A “hierarchical part list” table

Widget > Add table from CSV

The “Add a table from CSV” menu allows you to create a table in the PDF document from external data defined in a CSV.

Creation of a table from CSV

This table is generated from a chosen CSV file.

1. Within the Tetra4D Enrich toolbar, choose Widget > Add table from CSV.
2. Drag a rectangle to define the location and the size of the table.
3. Use the frame controllers to resize the table if required.
4. Drag the table border to reposition the table if required.
5. Adjust the table properties to your specifications by selecting the options in the Edit panel in the right.

Note: Refer to [Definition of the part list and table settings](#) to have detailed explanations about how to customize the table presentation.

6. Click on the green check “Validate the table modifications” icon to save the carousel, or
7. Click on the red “X” “Cancel the table modifications” icon to discard the changes.

*Table created from a CSV file has no link with the 3D parts of the 3D annotation.
To map table rows with 3D parts, refer to “[3D Attributes / 3D Mapping](#)” section.
To create actions triggered by a selection of a row of the table, refer to “[On table row](#)” section.*

Remark: CSV format

The CSV format expected by Tetra4D Enrich is shown below:

Column 1 title;Column 2 title;Column 3 title

C1 R1 value;C2 R1 value;C3 R1 value

C1 R2 value;C2 R2 value;C3 R2 value

C1 R3 value;C2 R3 value;C3 R3 value

The first line of the CSV file will be used to define the title of the columns in the table.

The separator must be “;”.

Column 1 title	Column 2 title	Column 3 title	▲
C1 R1 value	C2 R1 value	C3 R1 value	
C1 R2 value	C2 R2 value	C3 R2 value	
C1 R3 value	C2 R3 value	C3 R3 value	▼

A “Table from CSV” table

Widget > Add table from clipboard

The “Add a table from clipboard” menu allows you to create a table in the PDF document from the system clipboard.

Creation of a table from clipboard

A table can be defined using data that is stored on the system clipboard. This is very similar to adding the table from a CSV file – the only difference is that instead of showing a dialog to select a CSV file, Tetra4 Enrich will grab the data automatically from the clipboard.

1. Make sure the clipboard contains the table information. Then, within the Tetra4D Enrich toolbar, choose Widget > Add table from clipboard.
2. Drag a rectangle to define the location and the size of the table.
3. Use the frame controllers to resize the table.
4. Drag the table border to reposition the table if required.
5. Adjust the table properties to your specifications by selecting the options in the Edit panel in the right.

Note: Refer to [Definition of the part list and table settings](#) to have detailed explanations about how to customize the table presentation.

6. Click on the green check “Validate the table modifications” icon to save the table, or
7. Click on the red “X” “Cancel the table modifications” icon to discard the changes.

Tables created from the clipboard have no link with the 3D parts of the 3D annotation. To map table rows with 3D parts, refer to [“3D Attributes / 3D Mapping”](#).

To create actions triggered by a selection of a row of the table, refer to [“On table row”](#) section.

Remark: Format of information copied in the clipboard

The contents of the clipboard must correspond to a table having multiple lines and rows. The column titles must be defined by the first row.

Supported applications to copy the table information in the clipboard are Microsoft Excel and Google Sheets.

	A	B	C
1	Column 1 title	Column 2 title	Column 3 title
2	C1 R1 value	C2 R1 value	C3 R1 value
3	C1 R2 value	C2 R2 value	C3 R2 value
4	C1 R3 value	C2 R3 value	C3 R3 value

Information in a spreadsheet (before being copied in the clipboard)

Column 1 title	Column 2 title	Column 3 title	▲
C1 R1 value	C2 R1 value	C3 R1 value	
C1 R2 value	C2 R2 value	C3 R2 value	
C1 R3 value	C2 R3 value	C3 R3 value	▼

Corresponding “Table from clipboard”

Definition of the part list and table settings

The Edit panel contains several settings to define the layout of the part list and table and to map its content with the 3D model if required.

Hover your mouse over any of the buttons to see the specific command.

- **Global settings:** Defines the colors and the font information.
- **Emphasize:** Defines how the selected part will be emphasized in the 3D annotation.
- **Column alignment:** Defines the alignment of a selected column.
- **Add or remove columns:** Enables you to add or remove a column.
- **3D Attributes / 3D Mapping:** Defines what information is displayed in a selected column and enables you to map the table with the 3D model if required.

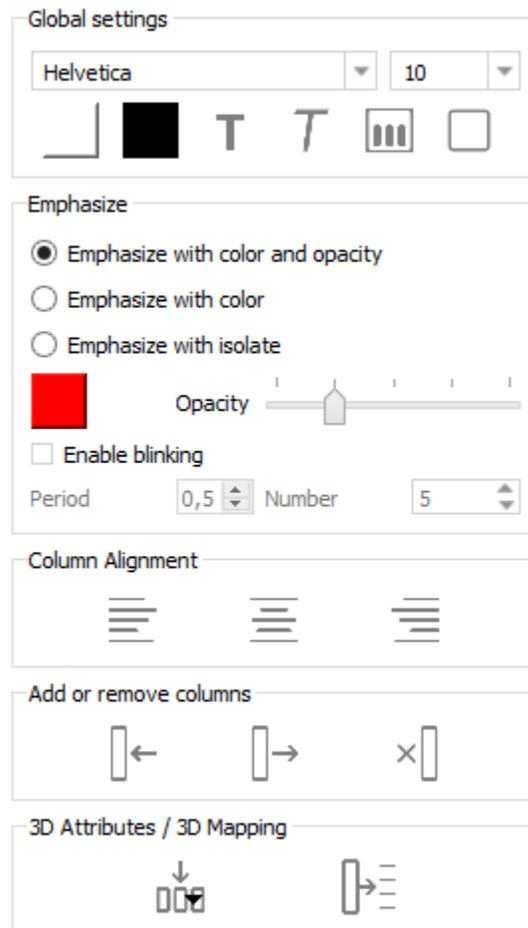

Edit panel for the table

Global settings subpanel

- **Font settings:** Defines the font and the font size of all the information visible in the table.
- **Font color, Bold, Italic:** Defines the color and text attributes of all the information visible in the table.

-  **Background color:** Defines the background color of the table.

Note: The background color applies to the full table.

-  **Make header bold:** set the header of the table to bold

Note: This setting enables to display header in bold while the table is displayed as non-bold.

- **Add a border:** Draws a frame around the table.

Note: The frame settings (color, thickness) are fixed and can't be modified.



Global settings area of the table edit panel

Emphasize subpanel

The Emphasize feature allows you to control how parts corresponding to the selected row in the table are emphasized in the 3D annotation.

There are three possibilities:

- **Emphasize with color and opacity:** Parts are emphasized by a color change while all the other parts are displayed with opacity.
- **Emphasize with color:** Parts are emphasized by a color change while all the other parts remain displayed without any change.
- **Emphasize with isolate:** Parts are emphasized by an “isolate” operation (they remain visible and all the other parts are hidden). A “fit-all” operation is automatically performed in order to zoom to the emphasized parts

Depending on the chosen emphasize mode, some additional settings are available:

-  **Emphasize color:** Defines the color used to emphasize the search results.
- **Opacity slider:** Defines the opacity value, when the “Emphasize with color and opacity” mode is selected.
- **Enable blinking:** Activates blinking of the search results.

Blinking is defined by two parameters:

- **Period:** Defines the period time (in seconds) for every blink of the parts.
- **Number:** Defines the number of blinking that occur for any highlight event.

Note: The “Enable blinking” option is not available with the “Emphasize by isolate” mode.

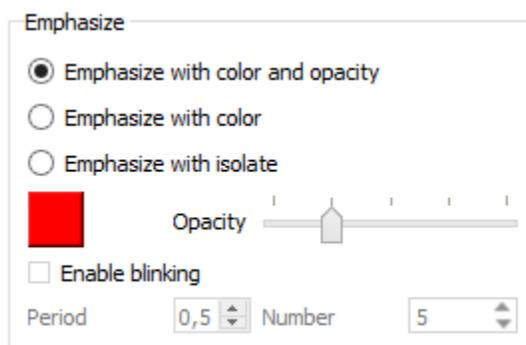

Emphasize settings area of the Table panel

Column Alignment settings

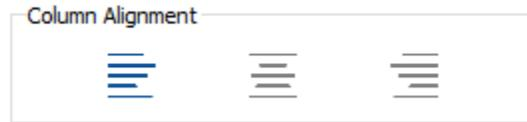

Column alignment settings area of the Table edit panel

-  **Align left:** Align the selected column to left.
Note: This setting applies to the selected column. The selected column is the one in which the mouse cursor is placed.
-  **Align Center:** Align the selected column to center.
Note: This setting applies to the selected column. The selected column is the one in which the mouse cursor is placed.
-  **Align right:** Align the selected column to right.
Note: This setting applies to the selected column. The selected column is the one in which the mouse cursor is placed.

Add or remove columns settings



Add or remove column settings area of the Table edit panel

-  **Insert column to the left:** Insert a new column to the left of the selected one.
Note: The selected column is the one in which the mouse cursor is placed.
-  **Insert column to the right:** Insert a new column to the right of the selected one.
Note: The selected column is the one in which the mouse cursor is placed.
-  **Delete column:** Delete the selected column.
Note: The selected column is the one in which the mouse cursor is placed.

3D Attributes / 3D Mapping subpanel

The 3D Attributes feature allows you to control which data is displayed in the columns of the table.

In case of a [Part list \(flat or hierarchical\)](#), the following information is listed in the table by default:

- row number (title of column: #, name in the list of attributes: #Computed #),
- part name (title of column: NAME, name in the list of attributes: #Computed NAME),
- quantity (title of column: QTY, name in the list of attributes: #Computed QTY).

However, it is possible to display different information in one existing column, or in an added column.

The 3D Mapping feature allows you to map the information currently displayed in the table with the 3D model. This feature is meant to be used with tables created using the features [Add table from CSV](#) or [Add table from clipboard](#).

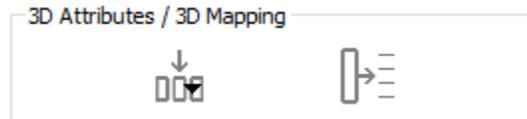

3D Attributes / 3D Mapping Settings area of the Table edit panel

-  **Fill column with attribute:** Fill the selected column with attributes linked to the 3D model.
 1. Select the column you want to fill by selecting a cell in the column. There is no need to select the full column, just the top row of the column.
 2. Click on the Fill column with attributes icon.
 3. Select the attribute in the list of attributes from the dropdown.
 4. Check the result in the table.

The attributes that are listed in the list depend on the CAD model currently loaded in the PDF document, and on the additional attributes that may have been imported in the PDF document using the [“ADD 3D attribute”](#) feature.

The default information that is listed in the table consists of:

- Row number (title of column: #, name in the list of attributes: #Computed #),
- Part name (title of column: NAME, name in the list of attributes: #Computed NAME),
- Quantity (title of column: QTY, name in the list of attributes: #Computed QTY).

	#Computed #
	#Computed NAME
	#Computed QTY
	InstanceName
	ItemNumber
	Material
	Nomenclature
	PartNumber
	Revision
	SUPPLIER
	SUPPLIER_REFERENCE
	Source

List of attributes provided by the Fill column with attribute feature

Remark:



: System information (default information displayed when the table is created).



: Attributes that have been imported and linked to the 3D parts.



: (no icon) Attribute defined in the CAD data (so that have been read while adding the 3D information in the PDF document).

-  **Map selected column with 3D parts:** Use the selected column to map the rows of the table with the 3D parts.
 1. Create the table using “Add table from CSV” or “Add table from clipboard” features.
Note: See detailed explanations on [“Add table from CSV”](#) or [“Add table from clipboard”](#).
 2. Select the column you want to use as a key for the mapping by selecting a cell in the column.
Note: An example is provided next page.
 3. Click on the Map selected column with 3D parts icon.
 4. Check the result of the mapping in the dialog that pops-up.
 5. Click OK to close the dialog.

The “Map selected column with 3D parts” feature is available with tables created using the [“Add table from CSV”](#) or [“Add table from clipboard”](#) features.

In the case of a table created using the [Part list \(flat or hierarchical\)](#) feature, this function will not be active, because these tables are already linked with the 3D data.

Mapping the rows of the table with 3D parts enables a cross-highlight between the table and the 3D annotation, when selecting a row in the table or when selecting a part in the 3D annotation.

The “mapping” means “correlate the values from this column to the corresponding 3D part”. The column title is important, because it is the key used to perform the mapping. For example, if the column title is “ItemNumber”, the mapping will work if the 3D parts contain an attribute named “ItemNumber”.

Enrich will look for all the parts, and make the mapping between the table row and a particular part that matches ItemNumber.

Remark: Example of mapping between a CSV table and the 3D parts

The table below is mapped with the 3D parts based on the column ItemNumber (in this example, ItemNumber is an attribute which is defined in all the 3D parts).
 Once the table has been inserted in the document, the ItemNumber column must be selected and the feature “Map selected column with 3D parts” will execute the mapping based on this key.
 Afterwards, the mapping is managed by looking at all the values listed in the column of parts attributes. The table row and part become linked when the value of the key attribute for a 3D part matches with the value of the attribute present in the table.
 Below, the main housing part is linked to the highlighted table row because the ItemNumber values are the same: H7894561.

Property	Value
Node Type	Component
Number of Lights	0
Number of Children	1 (1)
Number of Vertices	0 (5892)
Number of Faces	0 (6218)
Number of Textures	0
Bounding Box Size (mm)	(43.75, 57.69, 71.31)
Surface Area (sq. mm)	n/a
Volume (cu. mm)	n/a
InstanceName	HOUSING.1
ItemNumber	H7894561
Material	Steel
Nomenclature	
PartNumber	HOUSING

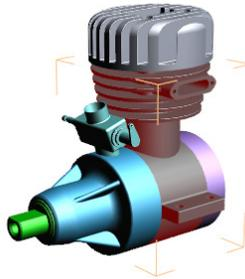

ItemNumber	Supplier	Supplier Reference
A4123589	Supplier A	RefA01
B2365891	Supplier B	RefB01
B4523687	Supplier C	RefC01
B4524789	Supplier D	RefD01
C1145783	Supplier E	RefE01
C4125364	Supplier F	RefF01
C4874562	Supplier G	RefG01
H1212556	Supplier A	RefA02
H4114567	Supplier B	RefB02
H5569123	Supplier C	RefC02
H7894561	Supplier D	RefD02
P1256398	Supplier E	RefE02
P4523698	Supplier F	RefF02
S2234587	Supplier G	RefG02
S2234796	Supplier A	RefA03

Mapping of the table rows with the 3D parts based on an attribute

The table below is mapped with the 3D parts based on the names of the parts.
 The names of the parts can be accessed using the key **#Computed NAME**.
 Consequently, the title of the column that contains the names of the parts must be **#Computed NAME**.

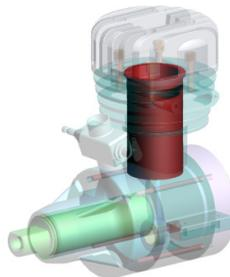
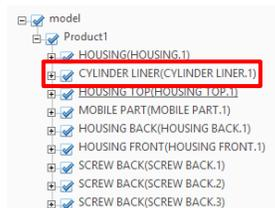

Excel spreadsheet			
	A	B	C
1	#Computed NAME	SUPPLIER	REFERENCE
2	HOUSING(HOUSING.1)	Supplier A	RefA01
3	CYLINDER LINER(CYLINDER LINER.1)	Supplier B	RefB02

#Computed NAME	SUPPLIER	REFERENCE
HOUSING(HOUSING.1)	Supplier A	RefA01
CYLINDER LINER(CYLINDER LINER.1)	Supplier B	RefB02

Mapping of the table rows with the 3D parts based on the names of the parts

Widget > Add Search

The “Search” is a widget that can be inserted in the PDF document to enable search operations on the 3D information that are present in the document.



A Search widget

Creation of a Search widget

1. Within the Tetra4D Enrich toolbar, choose Widget > Add Search.
2. Drag a rectangle to define the location and the size of the Search widget.
The rectangle cannot overlap with other Tetra4D Enrich items.
Once the rectangle is defined, the Search editor panel appears on the right.
3. Use the frame controllers to resize the search widget, if needed.
4. Adjust the Search widget properties to your specifications by selecting the commands in the Edit panel in the right.
5. Define the search criteria in the Edit panel in the right.

Note: Refer to [Search criteria subpanel](#) to have detailed explanations about the search criteria.

6. Click on the green check button “Validate the Search modifications” icon to save the Search widget, or
7. Click on the red “X” button “Cancel the Search modifications” icon to discard the changes.

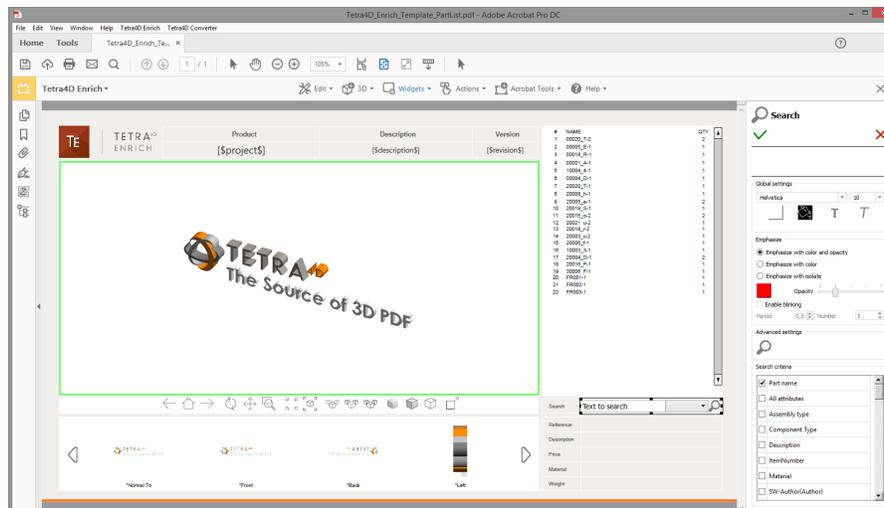

Creation of a Search widget

Definition of the Search widget

The Editor panel offers several settings to define the behavior and the layout of the Search widget.

Hover your mouse over any of the buttons to see the specific command.

- **Global settings:** Defines the colors and the font information for the widget.
- **Emphasize:** Defines how the searched parts will be emphasized in the 3D annotation.
- **Advanced settings:** Defines the icon used in the widget.
- **Search criteria:** Defines the search criteria that will be supported.

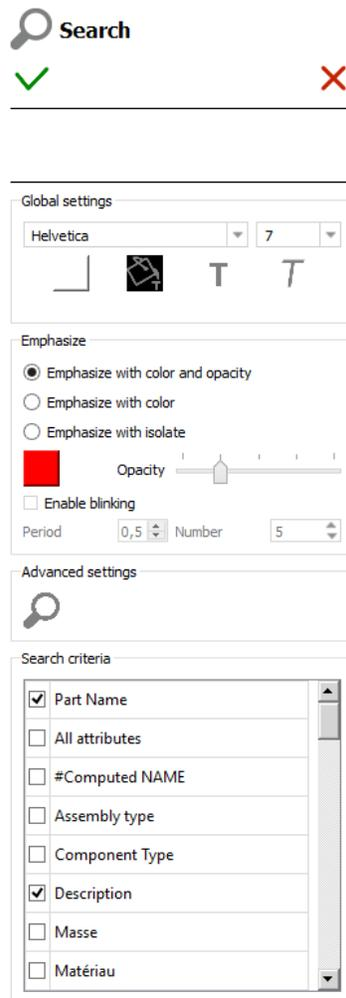

Edit panel for Search widget

Global settings subpanel

- **Font settings:** Defines the font and the font size for used in the search widget.
- **Font color, Bold, Italic:** Applies to the font used in the search widget.
-  **Background color:** Defines the background color of the Search widget.

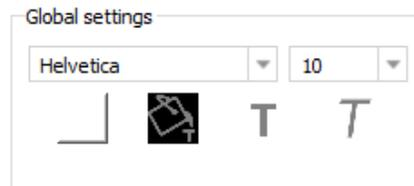

Global settings area of the search edit panel

Emphasize subpanel

The Emphasize feature allows you to control how the results of the search are emphasized in the 3D annotation.

There are three possibilities:

- **Emphasize with color and opacity:** The search results are emphasized by a color change while all the other parts are displayed with opacity.
- **Emphasize with color:** The search results are emphasized by a color change while all the other parts remain displayed without any change.
- **Emphasize with isolate:** The search results are emphasized by an “isolate” operation (they remain visible and all the other parts are hidden). A “fit-all” operation is automatically performed in order to zoom to the emphasized parts

Depending on the chosen emphasize mode, some additional settings are available:

-  **Emphasize color:** Defines the color used to emphasize the search results.
- **Opacity slider:** Defines the opacity value, when the “Emphasize with transparency” mode is selected.
- **Enable blinking:** Activates blinking of the search results.

Blinking is defined by two parameters:

- **Period:** Defines the period time (in seconds) for every blink of the parts.
- **Number:** Defines the number of blinking that occur for any highlight event.

Note: The “Enable blinking” option is not available with the “Emphasize by isolate” mode.

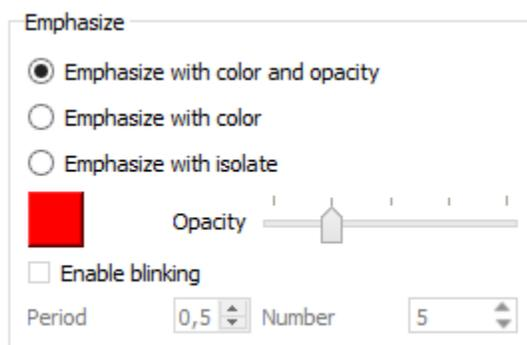

Emphasize settings area of the Search panel

Advanced settings subpanel

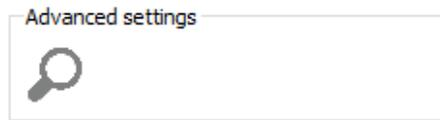

Advanced settings area of the Search edit panel

-  **Change the search button icon**
 - *The search icon that appear in the search widget can be changed by selecting a new image from the file system.*

Search criteria subpanel

The Search criteria feature allows you to define what search options will be accessible in the Search widget.

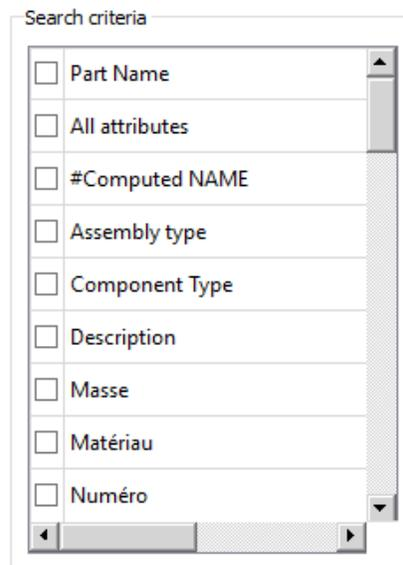

Search criteria settings area of the Search edit panel

Remark:

When the Search widget is created in the PDF document, the author must define what search criteria will be proposed to the consumer of the PDF document. It is for example possible to limit the search operation to the names of the parts, or to one or a few attributes. And conversely, the search can be performed on all the attributes linked to the parts from the 3D annotation.

There are several search criteria possibilities:

- **Part name:** The search will be performed on the names of the parts.
- **All attributes:** The search will be performed on all the attributes that are linked to the parts from the 3D annotation.
- **Attribute:** The search will be performed on the selected attributes only.

Remark:

The Search widget is composed by three different parts:

- *A field where user will enter the search string*
- *A dropdown list in which the search criteria is selected*
- *A button with Search icon that execute the search operation*



Example of Search operations performed with different criteria

The Search criteria feature allows you to define what search options will be accessible in the Search widget.

- **Search criteria: Part name**

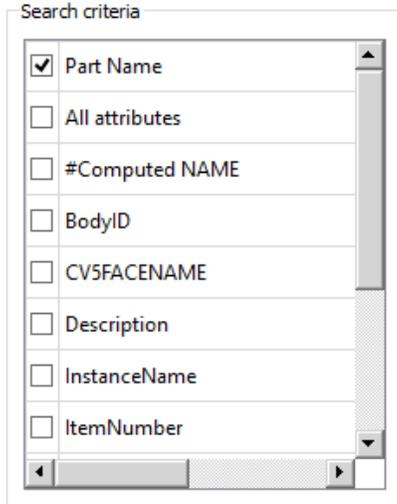

Search criteria (Authoring side)



Search widget (consuming side)

Remark:

Consumer can only execute search operation based on the part names

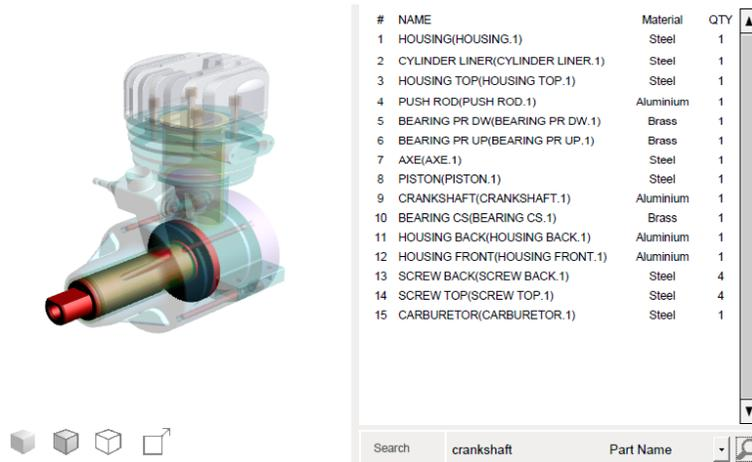

Results when searching for "crankshaft"

- Search criteria: All attributes

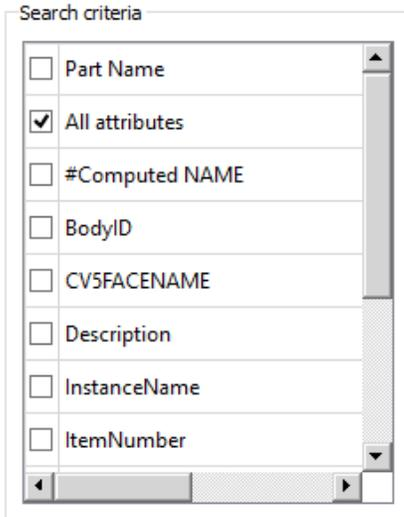

Search criteria (Authoring side)



Search widget (consuming side)

Remark:

Consumer can only execute search operation based on all the attributes



#	NAME	Material	QTY
1	HOUSING(HOUSING.1)	Steel	1
2	CYLINDER LINER(CYLINDER LINER.1)	Steel	1
3	HOUSING TOP(HOUSING TOP.1)	Steel	1
4	PUSH ROD(PUSH ROD.1)	Aluminium	1
5	BEARING PR DW(BEARING PR DW.1)	Brass	1
6	BEARING PR UP(BEARING PR UP.1)	Brass	1
7	AXE(AXE.1)	Steel	1
8	PISTON(PISTON.1)	Steel	1
9	CRANKSHAFT(CRANKSHAFT.1)	Aluminium	1
10	BEARING CS(BEARING CS.1)	Brass	1
11	HOUSING BACK(HOUSING BACK.1)	Aluminium	1
12	HOUSING FRONT(HOUSING FRONT.1)	Aluminium	1
13	SCREW BACK(SCREW BACK.1)	Steel	4
14	SCREW TOP(SCREW TOP.1)	Steel	4
15	CARBURETOR(CARBURETOR.1)	Steel	1

Results when searching for "Aluminium" (the Material attribute has some Aluminium values)

- **Search criteria: Multiple criteria**

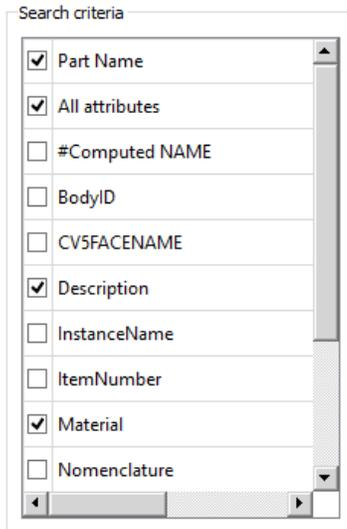

Search criteria (Authoring side)

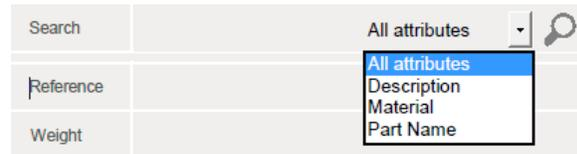

Search widget (consuming side)

Remark:

Consumer can choose what kind of search he wants to perform (all attributes, or only based on the “Material” attribute...)

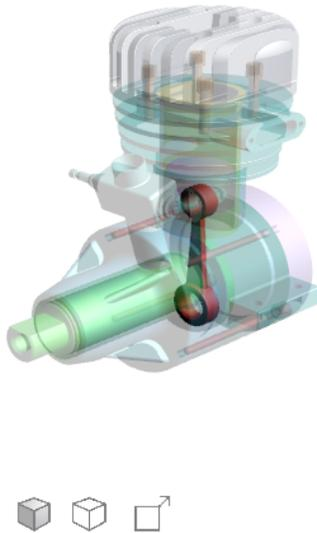

#	NAME	Material	QTY
1	HOUSING(HOUSING.1)	Steel	1
2	CYLINDER LINER(CYLINDER LINER.1)	Steel	1
3	HOUSING TOP(HOUSING TOP.1)	Steel	1
4	PUSH ROD(PUSH ROD.1)	Aluminium	1
5	BEARING PR DW(BEARING PR DW.1)	Brass	1
6	BEARING PR UP(BEARING PR UP.1)	Brass	1
7	AXE(AXE.1)	Steel	1
8	PISTON(PISTON.1)	Steel	1
9	CRANKSHAFT(CRANKSHAFT.1)	Aluminium	1
10	BEARING CS(BEARING CS.1)	Brass	1
11	HOUSING BACK(HOUSING BACK.1)	Aluminium	1
12	HOUSING FRONT(HOUSING FRONT.1)	Aluminium	1
13	SCREW BACK(SCREW BACK.1)	Steel	4
14	SCREW TOP(SCREW TOP.1)	Steel	4
15	CARBURETOR(CARBURETOR.1)	Steel	1

Search: rod Description

Results when searching for “rod” as a description

Actions

The Actions menu allows you to define interactivity between different items within the PDF document, for example:

- Clicking a button will activate a 3D view and will display text in a text field,
- Selecting a part in the 3D annotation (or in the part list) will display several attributes of the part in different text fields...

The actions are defined first by a trigger, and secondly by the operation that will be executed afterwards.

Overview

The actions can be triggered by several means:

- **On button**: the interactivity is triggered by a click on a button.
- **On 3D view**: the interactivity is triggered by the activation of an existing 3D view.
- **On 3D part**: the interactivity is triggered by the selection of any part in the 3D annotation.
- **On table row**: the interactivity is triggered by the selection of a row in a table.

The actions that can be executed afterwards are:

- **Activate View**: Activates a specified 3D view.
- **Previous View**: Activates the previous 3D view.
- **Next View**: Activates the next 3D view.
- **Render Mode**: Activates a chosen render mode.
- **Node Color**: Sets a predefined color and transparency to a specified 3D part.
- **Node Visibility**: Changes the visibility of a selected 3D part.
- **Set Text In Field**: Outputs text to a text (or a button) field.
- **Rotate**: Changes the mouse main control (left button) to Rotate mode (which is the default mode).
- **Pan**: Changes the mouse main control (left button) to Pan mode.
- **Zoom**: Changes the mouse main control (left button) to Zoom mode.
- **Fit Visible**: Displays all the visible parts and reset the center of rotation point in the view.
- **Fit Selected**: Adjusts the zoom in the 3D annotation to fit to a selected 3D part.
- **Full Screen Mode**: Toggle the display mode of the document to full screen / document modes.

Remark:

This section will first present the different triggers and then all the possible actions.

Actions > On Button

The actions will be triggered by pressing a button present in the PDF document.

Remark:

*The buttons must be defined prior to the creation of the action.
Refer to [“Add button”](#) for instructions on how to create buttons.*

1. Within the Tetra4D Enrich toolbar, choose Action > On Button.

Note: *The existing buttons in the active page of the PDF document are highlighted:*

- In orange, if no action has been defined on the button,
- In green if an action has already been defined.

2. Select the button.

Note: *Once selected, the button is highlighted in green.*

3. In the Actions panel, which appears on the right, define the name of the sequence of actions (optional).

Note: *Several actions can be created in one sequence.*

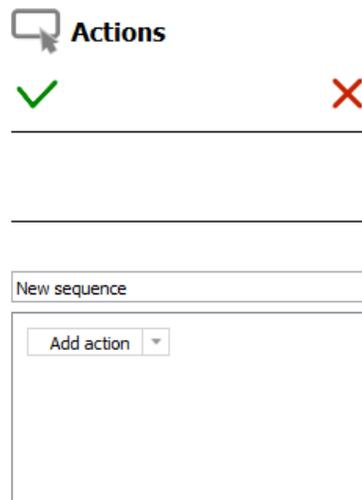

The Actions panel corresponding to the “On button” trigger

4. Use the drop-down list “Add action” to select the action to be executed.

Note: refer to [Description for actions](#) for explanations on the different types of actions.

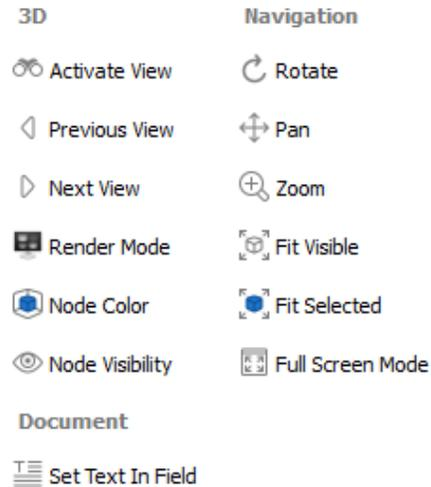

The different types of actions available for the “On button” trigger

5. Define the action properties in the action panel that appears.

Note: refer to [Description for actions](#) for explanations on the different types of actions.

6. Click on the “Add action” drop down list to add a new action to the current sequence of actions, or
7. Click the green check to save the action, or
8. Click the red “X” to cancel the operation.

Actions > On 3D view

The activation of an existing 3D view can be used to trigger interactivity inside the PDF document. The views must be defined in the 3D annotation prior the creation of the action.

1. Within the Tetra4D Enrich toolbar, choose Action > On 3D view.
2. Select the 3D annotation (if several are present in the active page of the PDF document).
Note: *If the active page contains only one 3D annotation, the 3D annotation is automatically selected and highlighted in green.*
3. In the Actions panel that appears in the right, click on the “Trigger view name” drop down list to select the 3D view that will trigger the action.

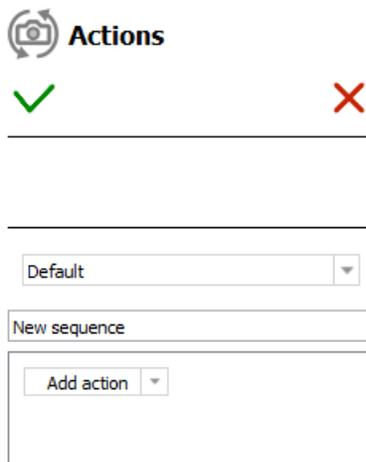

The Actions panel for a “On 3D view” trigger

4. Define the name of the sequence of actions (optional).
Note: *Several actions can be created in one sequence.*
5. Click on the “Add action” drop down list to select the action to be executed.
Note: *refer to [Description for actions](#) for explanations on the different types of actions.*

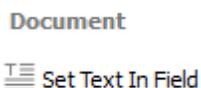

The different types of actions available for the “On 3D view” trigger

6. Define the action properties in the action panel that appears.

Note: refer to [Description for actions](#) for explanations on the different types of actions.

7. Click on the “Add action” drop down list to add a new action to the current sequence of actions, or
8. Click the green check to save the action, or
9. Click the red “X” to cancel the action.

Actions > On 3D part

The selection of a part in the 3D annotation or the selection of a row in a [part list \(flat\)](#) or [part list \(hierarchical\)](#) table can be used to trigger interactivity inside the PDF document.

1. Within the Tetra4D Enrich toolbar, choose Action > On 3D part.
2. Select the 3D annotation (if several are present in the active page of the PDF document).

Note: *If the active page contains only one 3D annotation, the 3D annotation is automatically selected and highlighted in green.*

3. In the Actions panel that appears in the right, define the action name (optional).

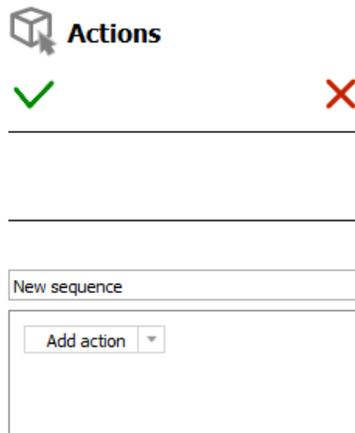

The Actions panel for a “On 3D part” trigger

4. Click on the “Add action” drop down list to select the action to be executed.

Note: refer to [Description for actions](#) for explanations on the different types of actions

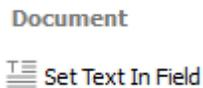

The different types of actions available for the “On 3D view” trigger

5. Define the action properties in the action panel that appears.

Note: refer to [Description for actions](#) for explanations on the different types of actions

6. Click on the “Add action” drop down list to add a new action to the current sequence of actions, or
7. Click the green check to save the action, or
8. Click the red “X” to cancel the action.

Actions > On table row

The selection of a row in a table can be used to trigger interactivity inside the PDF document.

1. Within the Tetra4D Enrich toolbar, choose Action > On table row
2. Select the row in the table

Note: The table is highlighted in orange before selection.

When clicking a table, the row is selected and highlighted in green.

If needed, it is possible to click another row from the same table.

3. Define the name of the sequence of actions (optional).

Note: Several actions can be created in one sequence.

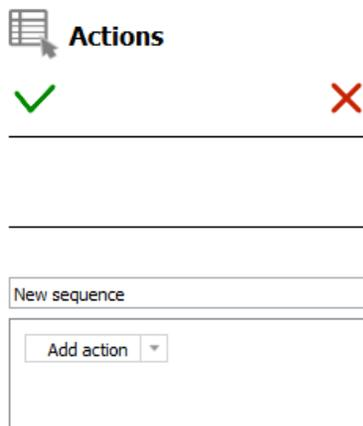

The Actions panel for a “On table row” trigger

4. Use the drop-down list “Add action” to select the action to be executed

Note: refer to [Description for actions](#) for explanations on the different types of actions.

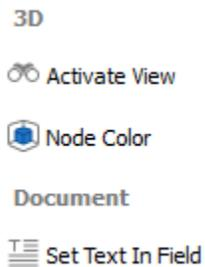

The different types of actions available for the “On table row” trigger

5. Define the action properties in the action panel that appears.

Note: refer to [Description for actions](#) for explanations on the different types of actions.

6. Click on the “Add action” drop down list to add a new action to the current sequence of actions, or
7. Click the green check to save the action, or
8. Click the red “X” to cancel the action.

Description of actions

This section presents the different types of actions and their related parameters.

Refer to “[Actions](#)” for explanations on how to trigger the actions.

Activate View

This action activates an existing 3D view.

1. In the Add action drop down list, select the Activate View menu.
2. Select the 3D annotation (if several are present in the active page of the PDF document).

Note: *If the active page contains only one 3D annotation, the 3D annotation is automatically selected and highlighted in blue.*

3. Select the view to be activated from the list of views.

Note: *The list shows all the existing views for the selected 3D annotation.*

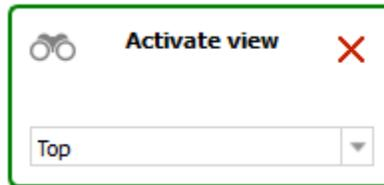

Activate view action definition panel

4. Click the green check at the top of the Actions panel to save the action, or
5. Click the red “X” in the “Activate view” panel to delete this action and keep the action definition panel open, or
6. Click the red “X” at the top of the Actions panel to cancel the action definition.

Previous View / Next View

These actions activate the Previous or the Next view in the 3D annotation.

1. In the Add action drop down list, select the Previous View or Next View.
2. Select the 3D annotation (if several are present in the active page of the PDF document).

Note: *If the active page contains only one 3D annotation, the 3D annotation is automatically selected and highlighted in blue.*

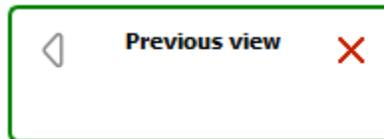

Previous view action definition panel

3. Click the green check at the top of the Actions panel to save the action, or
4. Click the red "X" in the "Previous view" or "Next view" panels to delete the action and keep the action definition panel open, or
5. Click the red "X" at the top of the Actions panel to cancel the action definition.

Render Mode

This action enables you to activate a specified render mode in the 3D annotation.

It is meant to provide the user with simple and direct access to common 3D render modes by clicking a button instead of using the standard tools available in the 3D annotation toolbar.

It is for example possible to put a few buttons in the PDF document to change the render mode to the most used modes (Solid, Solid outlined, Illustration...)

1. In the Add action drop down list, select the Render Mode menu.
2. Select the 3D annotation (if several are present in the active page of the PDF document).

Note: *If the active page contains only one 3D annotation, the 3D annotation is automatically selected and highlighted in blue.*

3. Select the render mode to be activated from the render mode drop down list.

Note: *The list shows the available render modes.*

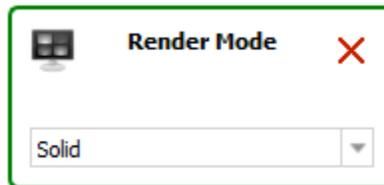

Render Mode action definition panel

4. Click the green check at the top of the Actions panel to save the action, or
5. Click the red “X” in the “Render Mode” panel to delete this action and keep the action definition panel open, or
6. Click the red “X” at the top of the Actions panel to cancel the action definition.

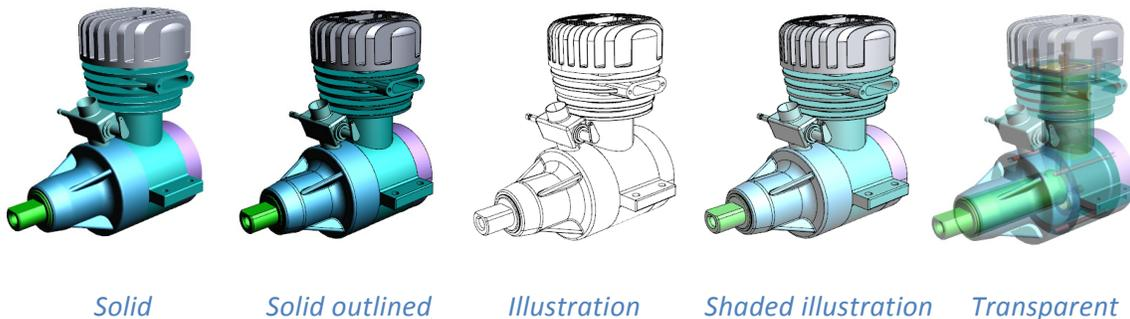

Node Color

This action enables you to highlight a part (or a group of part) by temporarily changing their color or transparency.

Remark:

This action is not generic because it applies to some selected 3D parts that are only present in the current PDF document.

1. In the Add action drop down list, select the Node Color menu.
2. Select the 3D annotation (if several are present in the active page of the PDF document).

Note: *If the active page contains only one 3D annotation, the 3D annotation is automatically selected and highlighted in blue.*

3. Select a part in the 3D annotation or in the data tree.

Note: *It is possible to select a group of parts by selecting a node in the data tree (i.e.: selection of a sub-assembly containing several parts).*

4. Select in the Color drop-down list the color to be applied to the selection.

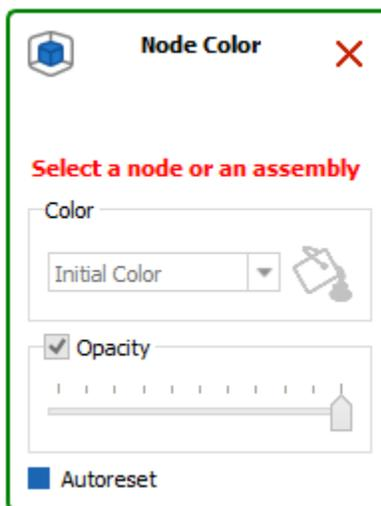

Node Color action definition panel

5. Define the transparency value to be applied to the selection by moving the Opacity slider.

Note: *it is possible in the same Node Color action to sequentially select different parts to change their color and transparency (different colors and transparency settings).*

6. Uncheck the “Autoreset” mark if you don’t want the initial part color and transparency to be restored when other actions will be triggered.
7. Click the green check at the top of the Actions panel to save the action, or
8. Click the red “X” in the “Node Color” panel to delete this action and keep the action definition panel open, or
9. Click the red “X” at the top of the Actions panel to cancel the action definition.

Node Visibility

This action enables to change the visibility of parts in the 3D annotation.

It is meant to provide the user with simple and direct access to common node visibility modes by clicking a button instead of using the contextual menus that are available in the 3D annotation.

It is for example possible to put a few buttons in the PDF document to change the visibility of selected parts (Isolate, Hide, Show all parts).

Remark:

The Hide and Isolate actions will apply on the parts that are selected in the 3D annotation.

The Show all action doesn't require any selection in the 3D annotation.

1. In the Add action drop-down list, select the Node Visibility item.
2. Select the 3D annotation (if several are present in the active page of the PDF document).

Note: *If the active page contains only one 3D annotation, the 3D annotation is automatically selected and highlighted in blue.*

3. Select the operation to be executed from the node visibility drop down list.

Note: *The list offers 3 operations:*

- Hide: Hides the selected part.
- Show all: Show all the parts that are present in the 3D annotation.
- Isolate: Isolates the selected part (Hide all the parts except the selected one).

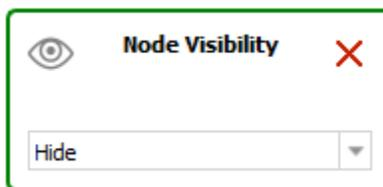

Node Visibility action definition panel

4. Click the green check at the top of the Actions panel to save the action, or
5. Click the red "X" in the "Node Visibility" panel to delete this action and keep the action definition panel open, or
6. Click the red "X" at the top of the Actions panel to cancel the action definition.

Set Text in Field

This action enables you to output a text in a text field or in a button.

Remark:

*The text fields must be defined prior the creation of the action.
Refer to [“Add text field”](#) for instructions on how to create text fields.*

Remark:

*When triggered by an [“On button”](#), [“On 3D view”](#), or an [“On table row”](#) event, the “Set text In Field” action enables output of predefined text (static) in a text field.
When triggered by a [“On 3D part”](#) event (selection of a part in the 3D annotation), the “Set text In Field” action can write static text or information about the selected part (CAD attributes or imported attributes) to a text field.*

1. In the Add action drop down list, select the Set Text in Field menu.
2. Select a text field or a button (where the text will be displayed).

Note: All the buttons and text fields from the active page are highlighted in orange.

Once selected, the text field or the button is highlighted in blue.

3. Define the text to be displayed: static text

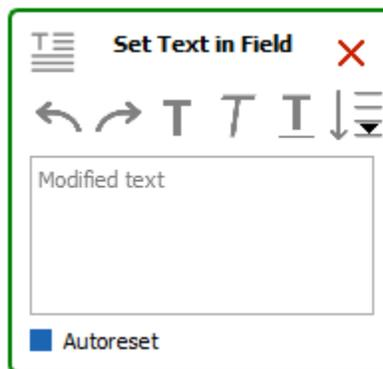

Set Text in Field action definition panel

- Define the text in the “Modified text” area.
-  : Click on the Undo / Redo icon if required.
-  Click on the different options to control the display of the text (Bold, Italic, Underlined).

4. Or define the 3D part attribute to be displayed in the text field:

-  : Click on the “Add selected Attribute into the text area.”
- Select the attribute in the list of attributes.

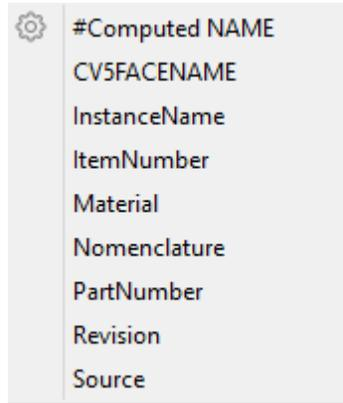

List of existing attributes

Note: After its selection in the list of available attributes, the attribute is identified in the text definition area as follows:

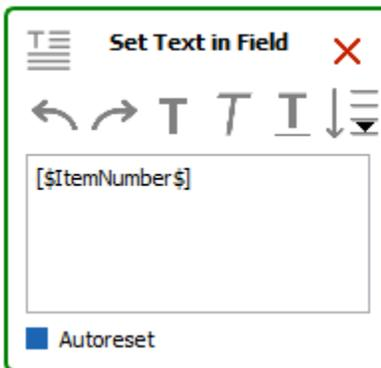

Set Text in Field action definition panel showing an attribute linked to the CAD part

5. Uncheck the “Autoreset” mark if you don’t want the text field being restored (emptied) when other actions will be triggered.
6. Click the green check at the top of the Actions panel to save the action, or
7. Click the red “X” in the “Set Text in Field” panel to delete this action and keep the action definition panel open, or
8. Click the red “X” at the top of the Actions panel to cancel the action definition.

Rotate / Pan / Zoon

These actions enable users to change the 3D operation accessed by using the left mouse button.

It is meant to provide the user with simple and direct access to the main 3D operations which control the display of the model (rotation of the 3D, Pan, zoom in and out).

It is for example possible to define buttons in the PDF document to give to the user access to these three operations by clicking the buttons, instead of using the standard 3D toolbar or 3D controls accessible through the left and right mouse buttons.

Remark:

These actions are directly executed and don't require any selection in the 3D annotation.

1. In the Add action drop down list, select the Rotate (or Pan or Zoom) menu.
2. Select the 3D annotation (if several are present in the active page of the PDF document).

Note: *If the active page contains only one 3D annotation, the 3D annotation is automatically selected and highlighted in blue.*

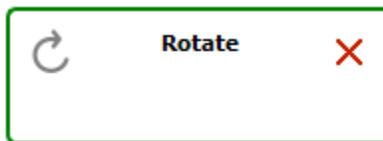

Rotate action definition panel

3. Click the green check at the top of the Actions panel to save the action, or
4. Click the red "X" in the "Rotate" panel to delete this action and keep the action definition panel open, or
5. Click the red "X" at the top of the Actions panel to cancel the action definition.

Fit visible

This action enables users to execute a Fit Visible operation in the 3D annotation.

This action is meant to provide users with simple and direct access to the Fit Visible operation to adjust the zoom so that all the currently visible parts will be visible in the 3D annotation and will also reset the center rotation point of the part/model.

It is for example possible to define a button in the PDF document to give to the user access to this Fit Visible operation by clicking the button, instead of using the standard 3D toolbar or the contextual menus that are available in the 3D annotation.

Remark:

This action is directly executed and doesn't require any selection in the 3D annotation.

1. In the Add action drop down list, select the Fit Visible menu.
2. Select the 3D annotation (if several are present in the active page of the PDF document).

Note: *If the active page contains only one 3D annotation, the 3D annotation is automatically selected and highlighted in blue.*

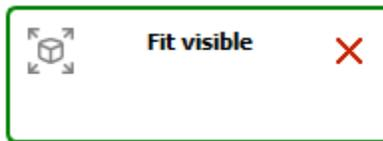

Fit visible action definition panel

3. Click the green check at the top of the Actions panel to save the action, or
4. Click the red "X" in the "Fit visible" panel to delete this action and keep the action definition panel open, or
5. Click the red "X" at the top of the Actions panel to cancel the action definition.

Fit selected

This action enables to execute a Fit Selected operation in the 3D annotation.

This action is meant to provide users with simple and direct access to the Fit Selected operation so that the zoom will be adjusted to make the selected part fit to the 3D annotation.

It is for example possible to define a button in the PDF document to give to the user access to this Fit Selected operation instead of using the contextual menus that are available in the 3D annotation.

Remark:

This action requires a part to be selected in the 3D annotation.

1. In the Add action drop down list, select the Fit Selected menu.
2. Select the 3D annotation (if several are present in the active page of the PDF document).

Note: *If the active page contains only one 3D annotation, the 3D annotation is automatically selected and highlighted in blue.*

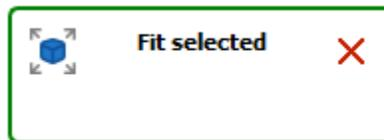

Fit selected action definition panel

3. Click the green check at the top of the Actions panel to save the action, or
4. Click the red "X" in the "Fit Selected" panel to delete this action and keep the action definition panel open, or
5. Click the red "X" at the top of the Actions panel to cancel the action definition.

Full Screen Mode

This action toggles full screen mode.

This action is meant to provide users with simple and direct access to the Full Screen Mode operation so that the document is displayed in full screen, and then can be displayed back inside Acrobat Pro or Acrobat Reader®.

It is for example possible to define a button in the PDF document to directly toggle the display mode, instead of using the top menu or the contextual menu that are available in the 3D annotation or the CTRL + L shortcut.

Remark:

This action is directly executed and doesn't require any selection in the 3D annotation. The activation of the full screen mode works only when no Acrobat Pro plug-in is open, including Tetra4D Enrich or Tetra4D Converter. In addition, none of the Acrobat Tools can be open. To close all plug-ins and tools, select the "Document" from the Acrobat menu bar as show in the image below.

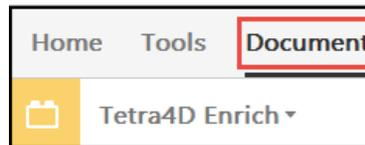

1. In the Add action drop down list, select the Full Screen Mode menu.
2. Select the 3D annotation (if several are present in the active page of the PDF document).

Note: *If the active page contains only one 3D annotation, the 3D annotation is automatically selected and highlighted in blue.*

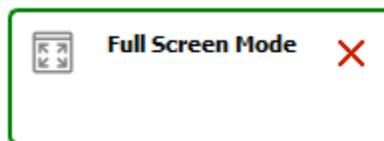

Full Screen Mode action definition panel

3. Click the green check at the top of the Actions panel to save the action, or
4. Click the red "X" in the "Full Screen Mode" panel to delete this action and keep the action definition panel open, or
5. Click the red "X" at the top of the Actions panel to cancel the action definition.

Edit

The Edit feature makes it possible to:

- Modify the content of the 3D annotation:
 - visibility of parts,
 - position of parts.
- Edit the existing Tetra4D Enrich widgets (Table, Carousel of views, Search)
- Edit the existing Tetra4D actions.

Edit 3D

This section shows a detailed explanation about the possible modifications of the 3D annotation.

1. Within the Tetra4D Enrich toolbar, choose Edit 3D.
2. In the Edit 3D panel, check the “Multiple selection” mark to toggle the parts selection mode between the standard Adobe Acrobat one and the Tetra4D Enrich “multiple selection” mode.

Note: Refer to [“Edit 3D: Selection modes”](#) to have detailed explanations about the selection feature provided by Edit 3D.

3. Use the selection features to control or modify the current selection.
4. Change the visibility of parts with the Visibility check mark, or

Note: Refer to [“Edit 3D: Control of part visibility”](#) to have detailed explanations about the status check behavior.

5. Check the mark “Activate transform feature” to enable the transform feature, and use the handler to move the selected parts.

Note: Refer to [“Edit 3D: Transform feature”](#) to have detailed explanations about the transform feature.

6. Click on the red “X” button to close the Edit 3D feature.

Edit 3D: Selection modes

The Edit 3D feature provides the ability to select several parts at the same time to ease and shorten the process of creating views when the visibility and/or the positions of parts must be changed.

Remark:

The selection mode of Adobe Acrobat makes it possible to select a single part or a group of parts if they all belong to the same hierarchical level of an assembly, but doesn't provide the ability to select simultaneously any parts from one assembly.

1. Check the Multiple selection mark to enable the multiple selection mode
2. Select in the 3D annotation the part to be added to the selection

Note: *The selected parts are highlighted in blue.*

3. Add a part to the selection set by selecting it in the 3D annotation

Note: *It is not required to press the CTRL Key to add a part to the selection.*

4. Click again an already selected part to unselect it
5. Select one the available feature (Visibility status or Transform), or

Note: *See below for details about selection features.*

6. Select one the Selection option to modify the selection set, or
7. Click into the 3D annotation to unselect all the parts

Remark:

When working with the Edit 3D feature, it is recommended not to select parts in the data tree because the multiple selection mechanism is designed for 3D selection of parts, and because it overrides the Adobe Acrobat standard selection feature (even when the multiple selection is not active).

Remark:

It is possible to switch between the standard Adobe Acrobat selection mode and the multiple selection mode during one selection sequence.

Selection mode subpanel

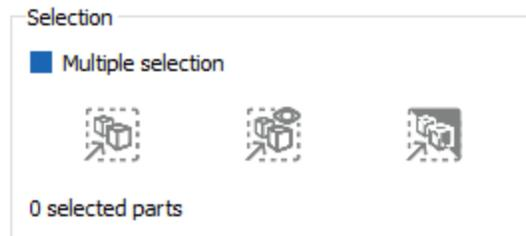

Selection area if the Edit 3D panel

- **Multiple selection:** Activates the multiple selection mode if checked.
- **Select all including invisible:** Selects all the parts from the 3D annotation, independently of their visibility status.
- **Select all visible:** Selects all the visible parts from the 3D annotation.
- **Invert visible selection:** Toggle the current selection considering only the visible parts.
- **X selected parts:** Shows the number of selected parts.

Example

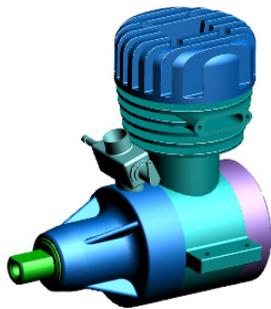

Selection of 2 parts



Invert selection



Select all visible

Edit 3D: Control of part visibility

The Visibility check mark provides a status about the visibility of the selected parts, and makes it possible to change this status. This feature is meant to be used in combination with the selection feature of the Edit 3D function.

1. Select a part (or several parts) in the 3D annotation
2. Optionally use the Selection options to modify the selection set
3. Click the Visibility mark to change the visibility status of the selected parts

Note: the parts don't remain selected after being hidden.

Remark:

Once defined, the visibility of the parts can be saved as Acrobat views.
It is mandatory to use the "Create view" feature to create an Acrobat view.
The view can be created without closing the Edit 3D feature.

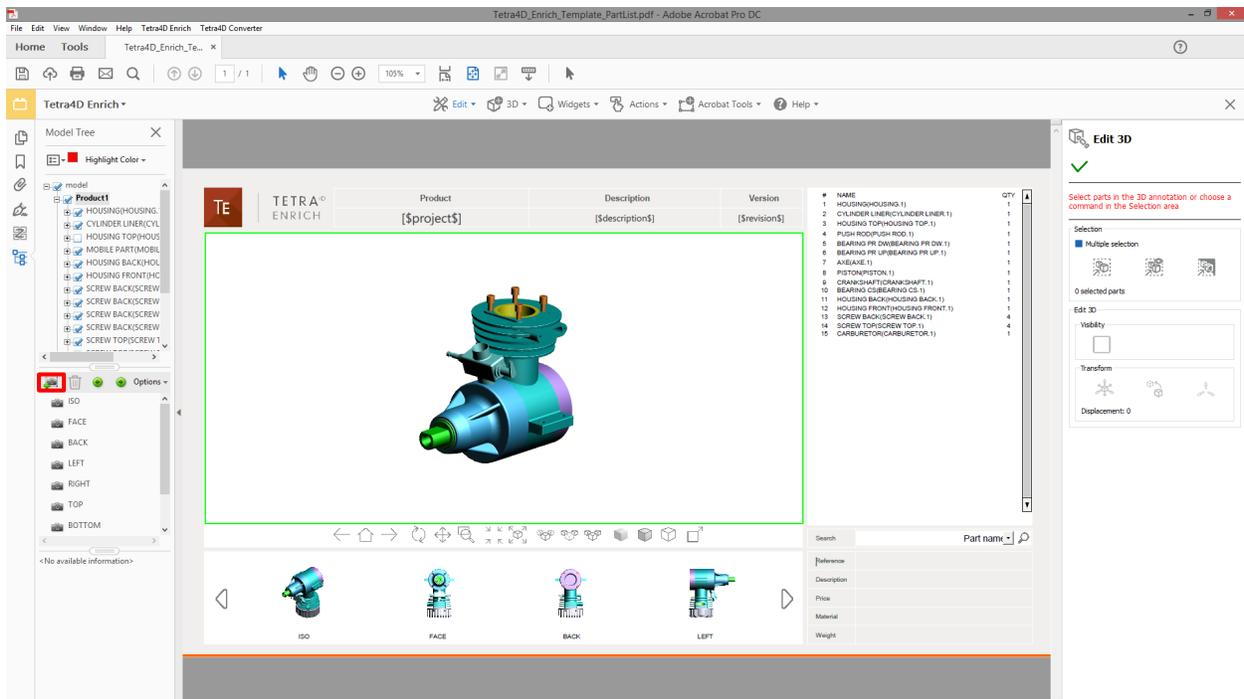

Create view icon in the data tree

Visibility subpanel



Visibility area if the Edit 3D panel

Example



All parts are visible



No selection: Status check is empty



Select one part

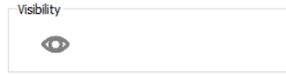

Status indicates that the part is visible

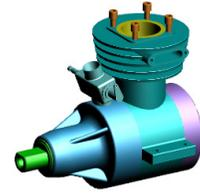

Click on visibility check



The part's status changes



Select all parts (including invisible)



Selection includes visible and invisible parts



Click on visibility one time



The first click turns all the selected parts to visible



Click another time



Part's status changes
The second click turns them off

Edit 3D: Transform feature

The Edit 3D feature provides the ability to modify the positions of the parts. The modification (translation) is manually defined by dragging a handler in the 3D annotation. This feature makes it possible to enhance the understanding of assemblies and to create exploded views when required.

1. Check the “Activate transform mode” mark
2. Select a part (or several parts) in the 3D annotation

Note: *The transform feature supports the “multiple selection” mode as well as the standard Acrobat one. The visibility status of the selected parts can be changed after a displacement.*

3. Click the arrow of the handler corresponding to the displacement direction and
4. Move the handler while keeping the mouse button pressed to move the selected parts
5. Use the three values (Axis 1, Axis 2, Axis 3) as indications of the current displacement
6. Click one or several times on “Change handler size” to temporarily resize the handler if required
7. Selected an already displaced part and click “Reset initial position” to position back the part to its initial position

Remark:

The handler is dimensioned based on the size of the global bounding box calculated with all the parts, independently of their visibility status.

Remark:

The modified positions of parts can be saved as Acrobat views.

It is mandatory to use the “Create view” feature to create an Acrobat view.

The view can be created:

- *without unselecting the parts (When the view is created, the handler will be automatically excluded and the selected part will also be temporarily displayed as unselected)*
- *without closing the Edit 3D feature.*

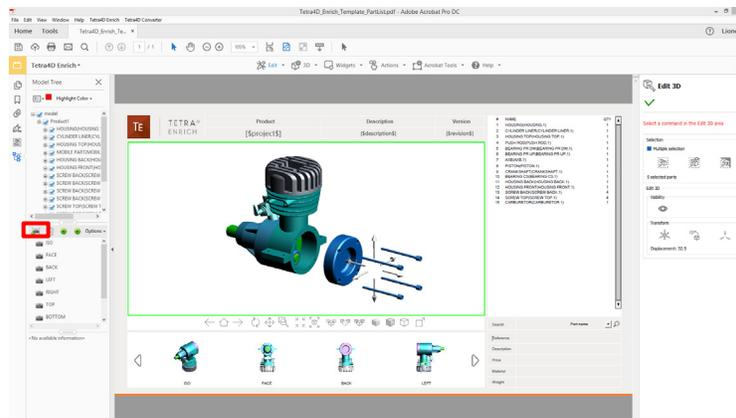

Create view icon in the data tree

Transform subpanel



Transform area if the Edit 3D panel

- **Activate transform mode:** Enables the transform feature.
- **Reset initial position of selected parts:** Sets the selected parts back to their initial positions.
- **Change handler size:** Changes the size of the handler (3 values).
- **Displacement:** Shows the current displacement value.

Example



Selection of the 4 screws

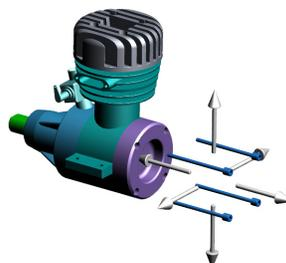

Displacement of the screws

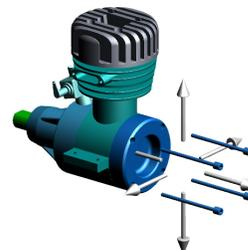

« Housing back » is added to the selection

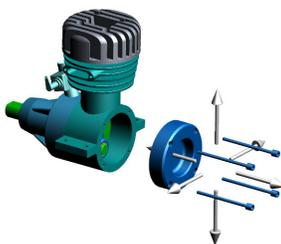

Displacement of the screws and the Housing

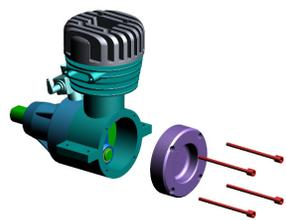

Parts are unselected

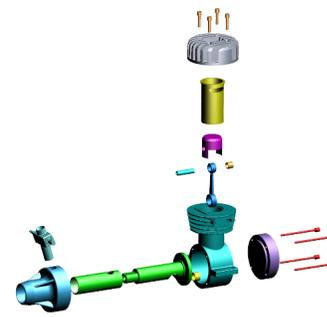

....Final exploded view

Remark:

*The transformed parts remain selected after a displacement enabling thus to add parts to the selection set and continue the displacement definition.
To clear the selection set, just click in the 3D annotation.*

Edit Widget: Carousel of views

This section shows detailed explanation about the modification of a Carousel of views.

1. Within the Tetra4D Enrich toolbar, choose Edit Widget.
2. Once the sidebar appears, select the Tetra4D Enrich widget to be modified.

Note: All the Tetra4D Enrich widgets are highlighted in orange.

Note: Clicking the red X cancels the edit operation.

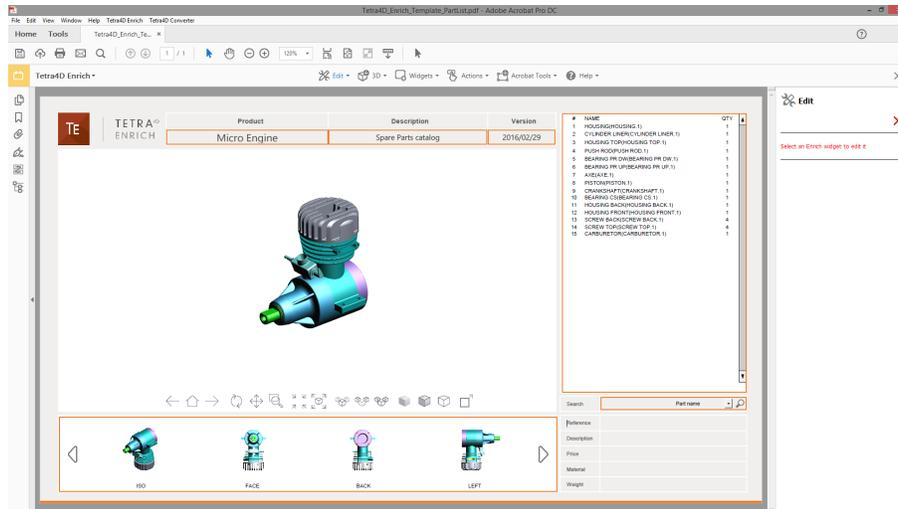

Highlighted widgets in the document – Edit sidebar on the right

3. Select the Carousel.

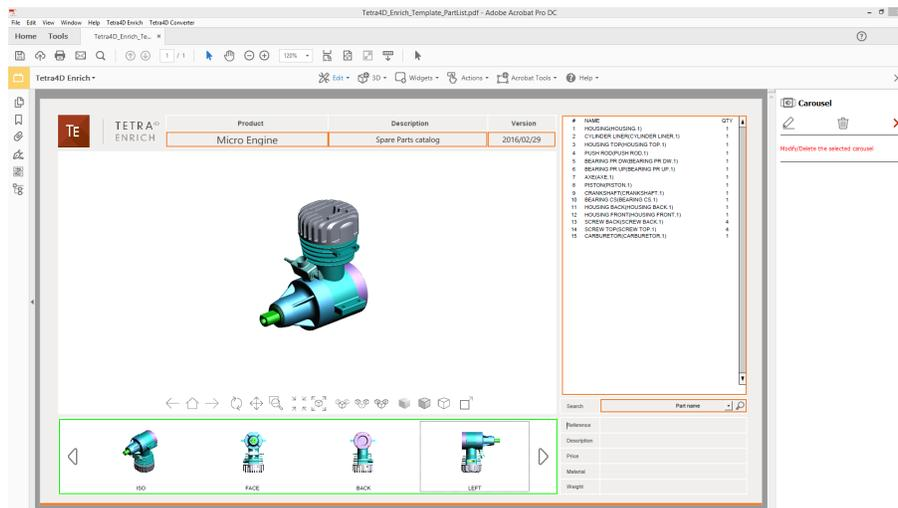

The Carousel of views is selected

4. Select the operation to be executed

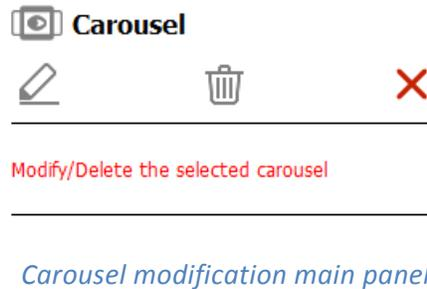

-  : Modify the selected item.
-  : Delete the selected item.
-  : Leave the Edit mode.

Remark:

*In Edit mode, all the settings related to the item are accessible in the Edit panel.
When deleting an item, a confirmation dialog box appears, so that it is possible to confirm or cancel the operation.
Once an item has been deleted, it is not possible to undo the operation.*

5. Click on the “Modify the selected item” icon to edit the Carousel properties, or
6. Click on the “Delete the selected item” icon to delete the Carousel, or
7. Click on the “Leave the edit mode” to cancel the operation.

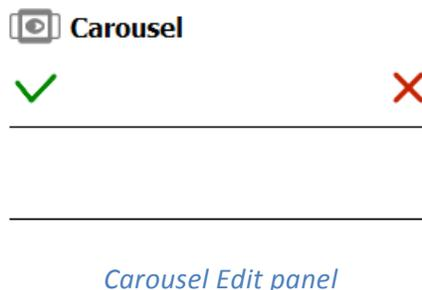

Remark:

If the “Modify the selected item” option has been chosen, refer to the [Carousel definition section](#) for detailed explanations about the Carousel settings.

8. Click on the green check to accept the modification, or
9. Click on the red “X” to cancel.

Edit Widget: Table

This section shows detailed explanation about the modification of a Table.

1. Within the Tetra4D Enrich toolbar, choose Edit Widget.
2. Once the sidebar appears, select the Tetra4D Enrich widget to be modified.

Note: All the Tetra4D Enrich widgets are highlighted in orange.

Note: Clicking the red X cancels the edit operation.

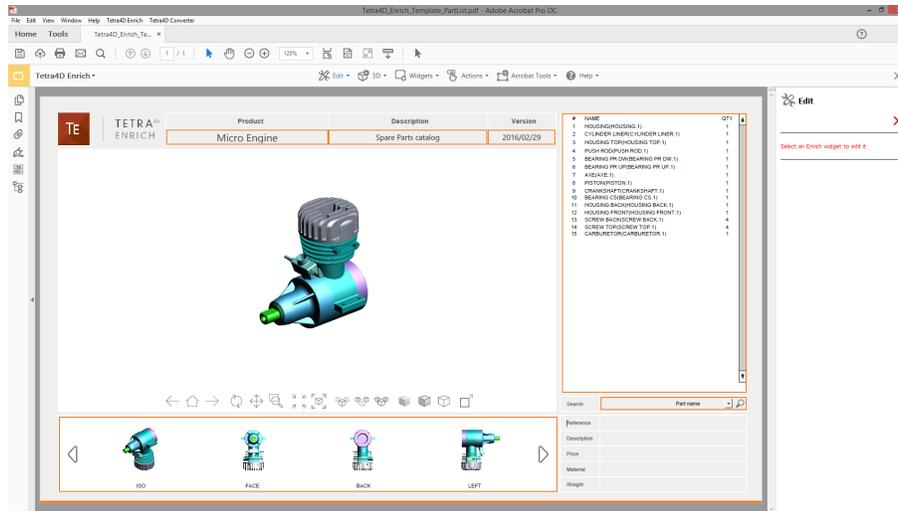

Highlighted widgets in the document – Edit sidebar on the right

3. Select the Table.

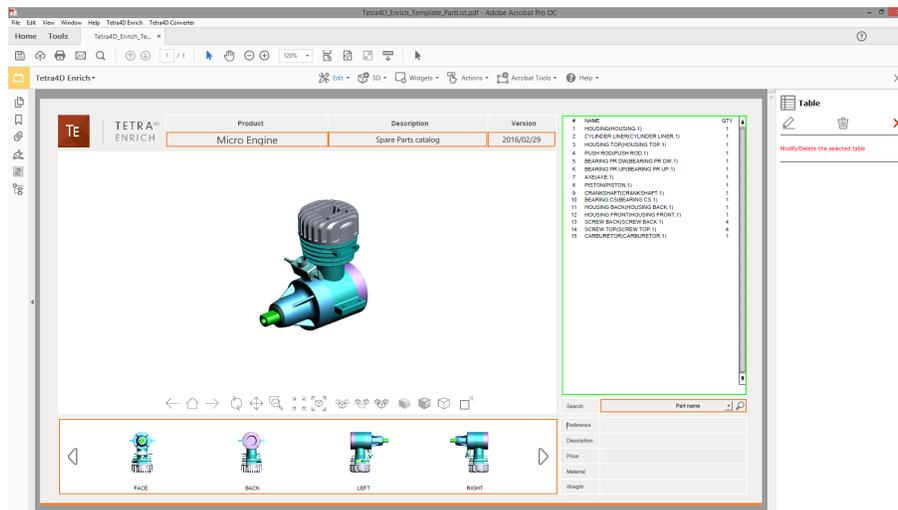

The Table is selected

4. Select the operation to be executed

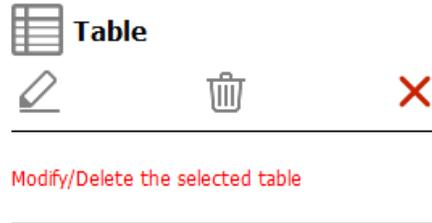

Table modification main panel

-  : Modify the selected item.
-  : Delete the selected item.
-  : Leave the Edit mode.

Remark:

*In Edit mode, all the settings related to the item are accessible in the Edit panel.
When deleting an item, a confirmation dialog box appears, so that it is possible to confirm or cancel the operation.
Once an item has been deleted, it is not possible to undo the operation.*

5. Click on the “Modify the selected item” icon to edit the table properties, or
6. Click on the “Delete the selected item” icon to delete the table, or
7. Click on the “Leave the edit mode” to cancel the operation.

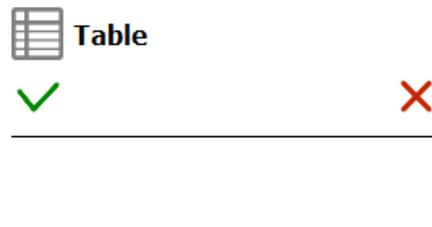

Table Edit panel

Remark:

If the “Modify the selected item” option has been chosen, refer to the [Table definition section](#) for detailed explanations about the Table settings.

8. Click on the green check to accept the modification, or
9. Click on the red “X” to cancel.

Edit Widget: Search

This section shows detailed explanation about the modification of a Search widget.

1. Within the Tetra4D Enrich toolbar, choose Edit Widget.
2. Once the sidebar appears, select the Tetra4D Enrich widget to be modified.

Note: All the Tetra4D Enrich widgets are highlighted in orange.

Note: Clicking the red X cancels the edit operation.

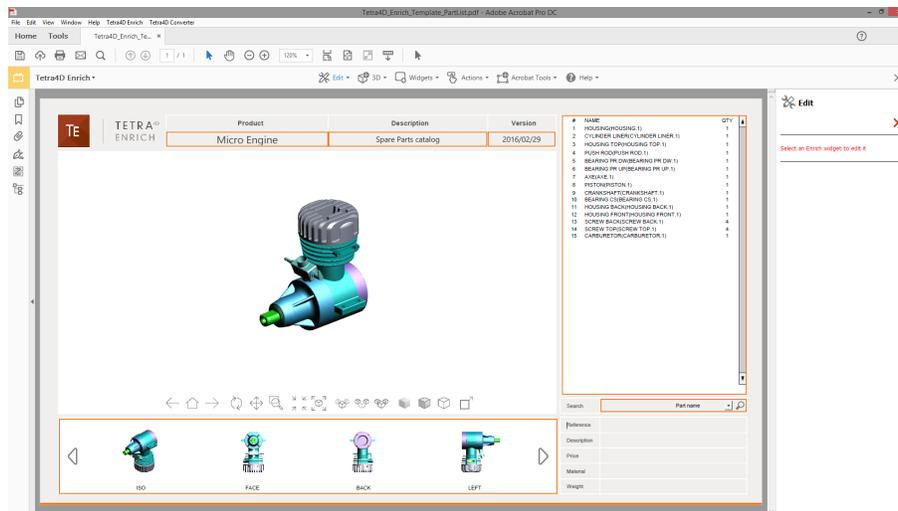

Highlighted widgets in the document – Edit sidebar on the right

3. Select the Search widget.

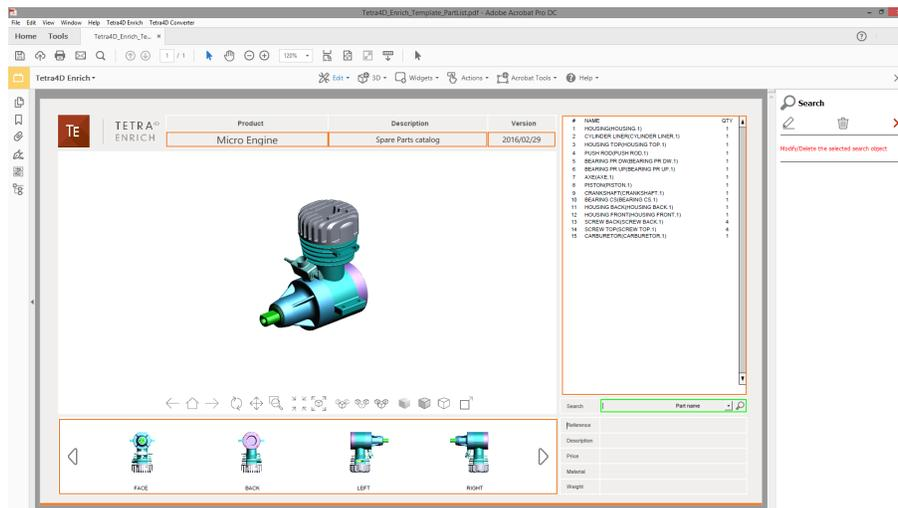

The Search widget is selected

4. Select the operation to be executed

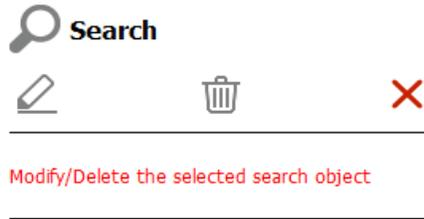

Search widget modification main panel

-  : Modify the selected item.
-  : Delete the selected item.
-  : Leave the Edit mode.

Remark:

*In Edit mode, all the settings related to the item are accessible in the Edit panel.
When deleting an item, a confirmation dialog box appears, so that it is possible to confirm or cancel the operation.
Once an item has been deleted, it is not possible to undo the operation.*

5. Click on the “Modify the selected item” icon to edit the Search widget properties, or
6. Click on the “Delete the selected item” icon to delete the Search widget, or
7. Click on the “Leave the edit mode” to cancel the operation.



Search widget Edit panel

Remark:

If the “Modify the selected item” option has been chosen, refer to the [Search widget definition section](#) for detailed explanations about the Search widget settings.

8. Click on the green check to accept the modification, or
9. Click on the red “X” to cancel.

Edit Actions

This section shows a detailed explanation about the modification of actions.

Remark:

The actions can be accessed by selecting their triggers only (because a sequence of actions can be assigned to one single trigger).

1. Within the Tetra4D Enrich toolbar, choose Edit.
2. Once the sidebar appears, select the trigger of the action to be modified.

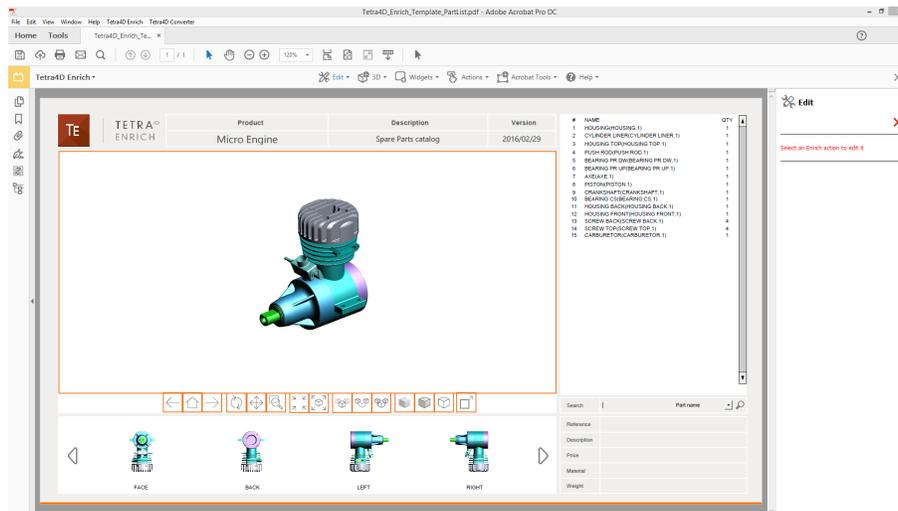

Highlighted triggers of Actions (Buttons and 3D Annotation)

Edit sidebar on the right

Remark:

The selection of the trigger may differ, depending on the trigger itself.

- [On button](#)
- [On 3D View](#)
- [On 3D part](#)
- [On table row](#)

On button action

1. Select the highlighted button that triggers the actions to be modified.



Selectable buttons

Remark:

*All the buttons having assigned actions are highlighted in orange.
Once a button has been selected, it is highlighted in green.*

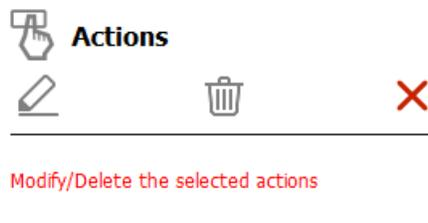

“On button” modification main panel

2. Click on the “Modify the selected item” icon to edit the actions assigned to this button, or
3. Click on the “Delete the selected item” icon to delete all the actions assigned to this button, or
4. Click on the “Leave the edit mode” to cancel the operation.

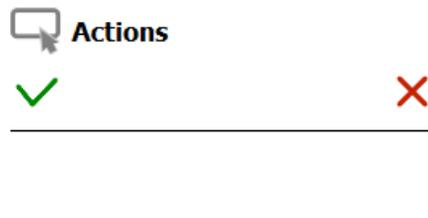

Action Edit panel

Remark:

If the “Modify the selected item” option has been chosen, refer to the [Action definition section](#) for detailed explanations about all the different actions settings.

5. Click on the green check to accept the modification, or
6. Click on the red “X” to cancel.

On 3D View action / on 3D part action

1. Select the highlighted 3D annotation in which the activation of a 3D view or the selection of any 3D part was defined as the trigger of the actions to be modified.

All the 3D annotations having assigned actions are highlighted in orange.

Once the 3D annotation has been selected, it is highlighted in green.

2. If required, select the trigger of the actions that must be modified.

Different types of triggers can be defined from events occurring in a 3D annotation:

- the activation of any 3D view or by the activation of a specific 3D view.
- the selection of any 3D part.

If some actions have been defined with these two types of triggers, the sidebar offers first to select the trigger.

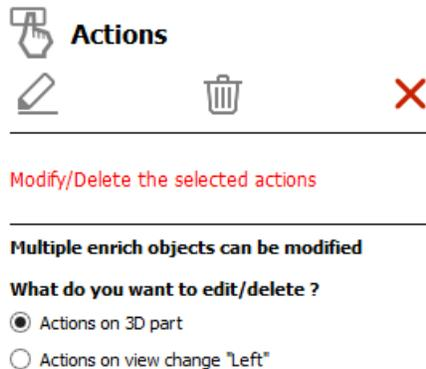

Selection of the trigger in case of multiple choices

3. Click on the “Modify the selected item” icon to edit the actions, or
4. Click on the “Delete the selected item” icon to delete all the actions assigned to this button, or
5. Click on the “Leave the edit mode” to cancel the operation.



Action Edit panel

Remark:

If the “Modify the selected item” option has been chosen, refer to the [Action definition section](#) for detailed explanations about all the different action settings.

6. Click on the green check to accept the modification, or
7. Click on the red “X” to cancel.

On table row action

1. Select the highlighted table in which the “On table row” action was defined.

Remark:

All the tables are highlighted in orange.

Once a table has been selected, it is highlighted in green.

2. If required, select the item to be modified.

Remark:

In case of a selection of a table, the Edit feature can apply to either the table itself, or to an “On table row” action, if any.

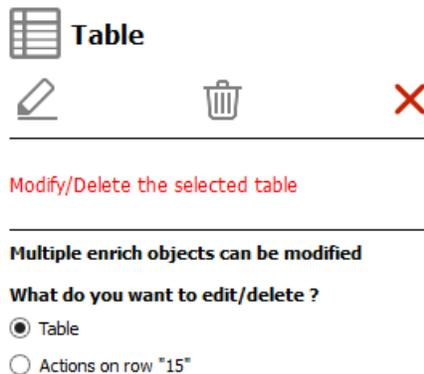

Selection of the trigger in case of multiple choices

3. Click on the “Modify the selected item” icon to edit the actions, or
4. Click on the “Delete the selected item” icon to delete all the actions assigned to this button, or
5. Click on the “Leave the edit mode” to cancel the operation.

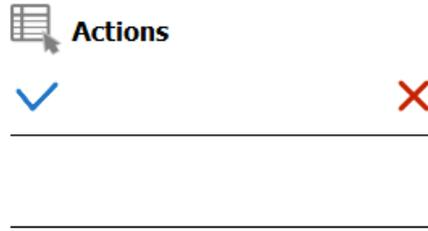

“On table row” action Edit panel

Remark:

If the “Modify the selected item” option has been chosen, refer to the [Action definition section](#) for detailed explanations about all the different actions settings.

6. Click on the green check to accept the modification, or
7. Click on the red “X” to cancel.

Edit Populate method for text fields

This section shows a detailed explanation about modifying the defined method to populate text fields.

1. Within the Tetra4D Enrich toolbar, choose Edit.
2. Once the sidebar appears, select the text field to be modified.



Text field populate method modification main panel

3. Click on the “Modify the selected item” icon to edit the populate method, or
4. Click on the “Delete the selected item” icon to suppress the defined populate method, or
5. Click on the “Leave the edit mode” to cancel the operation.

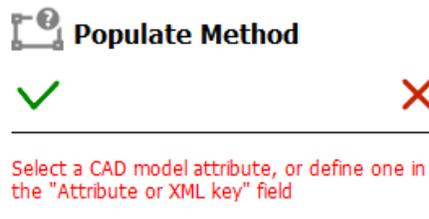

Populate method Edit panel

Remark:

If the “Modify the selected item” option has been chosen, refer to the description of the [“Set populate method for text fields”](#) for detailed explanations about the populate text field method settings.

6. Click on the green check to accept the modification, or
7. Click on the red “X” to cancel.

Acrobat tools

The Acrobat tools menu provides a direct access to some Acrobat features that are often used when creating documents with Tetra4D Enrich:

- Add button.
- Add text field.
- Select Object.

These features are for example are required to define actions with Tetra4D Enrich (ie: when a button is pressed, an action outputs a text in a text field...) and they may be accessed at any time.

Remark:

These functions can be accessed in Acrobat using:

- Prepare Form: Access to the add a text field and add a button
- Rich media: Access to the Select Object feature



Prepare Form toolbar



Rich Media toolbar

Add button

Allows a button to be created.

1. Within the Tetra4D Enrich toolbar, choose Acrobat Tools > Add Button.
2. Drag a rectangle to define the location and the size of the button.
3. Define the name of the button in the Field Name dialog that appears.

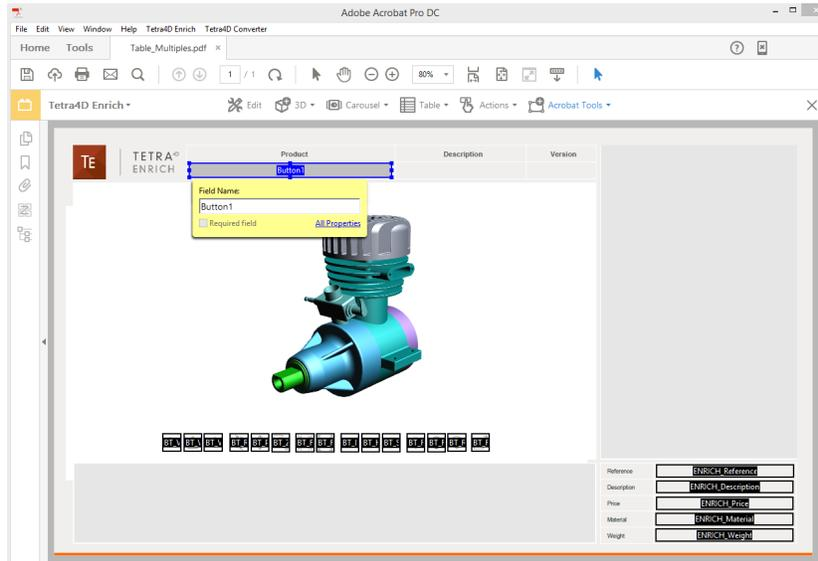

Creation of a button using the Acrobat Tools > Add button feature

4. Optionally click on the “All properties” option in the Field Name dialog to open the “Button Properties” dialog.

Note: The “Button Properties” dialog gives access to all the available options to define the layout of the button (name, color, icons if any...).

Note: Refer to the Acrobat user manual to have detailed explanations about buttons.

5. Once defined, click on the “Click to pan around the document” icon to activate the standard control of the document.

Note: The “Click to pan around the document” icon is accessible with the other page controls, that can be located at the bottom of the Acrobat window or that can be displayed in the toolbars.

Remark:

The “Add button” feature temporarily hides any existing table, carousel or search widget to limit the number of visible objects (text fields and buttons).

Note that using the Add button feature of the Prepare Form tool of Acrobat keeps all the text fields and buttons that define the Tetra4D Enrich widgets visible.

Add text field

Allows a text field to be created.

1. Within the Tetra4D Enrich toolbar, choose Acrobat Tools > Add text field.
2. Drag a rectangle to define the location and the size of the text field.
3. Define the name the text field in the Field Name dialog that appears.

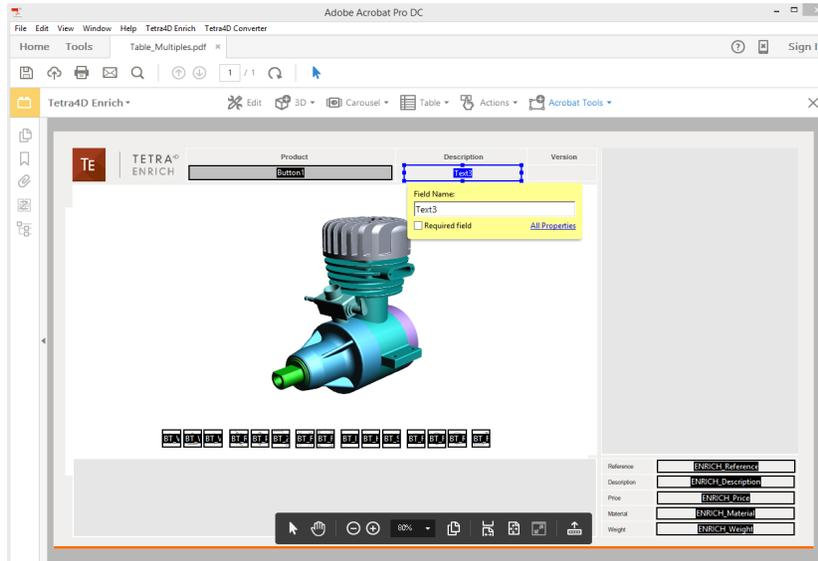

Creation of a text field using the Acrobat Tools > Add text field feature

4. Optionally click on the “All properties” option in the Field Name dialog to open the “Text Field Properties” dialog.

Note: The “Text Field Properties” dialog gives access to all the available options to define the layout of the text field (name, color, icons if any...).

Note: Refer to the Acrobat user manual to have detailed explanations about text fields.

5. Once defined, click on the  “Click to pan around the document” icon to activate the standard control of the document.

Note: The “Click to pan around the document” icon is accessible with the other page controls which can be located at the bottom of the Acrobat window, or which can be displayed in the toolbars.

Remark:

The “Add text field” feature temporarily hides any existing table, carousel or search widget to limit the number of visible objects (text fields and buttons).

Note that using the Add text field feature of the Prepare Form tool of Acrobat keeps all the text fields and buttons that define the Tetra4D Enrich widgets visible.

Edit object

The Edit object feature allows the user to modify Acrobat objects that are present in the PDF document, like buttons and text fields.

Remark:

It is important to note that Buttons and Text Fields are Adobe objects, and that they cannot be edited using the Tetra4 Enrich “[Edit](#)” feature, which is meant to edit Tetra4D Enrich items, such as tables, carousel of views, and actions.

1. Within the Tetra4D Enrich toolbar, choose Acrobat Tools > Edit object.
2. Select one of the highlighted Acrobat object (button or text field).

Note: make a double-click on the object or make a right click > Properties to open the Properties dialog for the selected object.

3. Make the changes and click Close in the Properties dialog to save the changes.

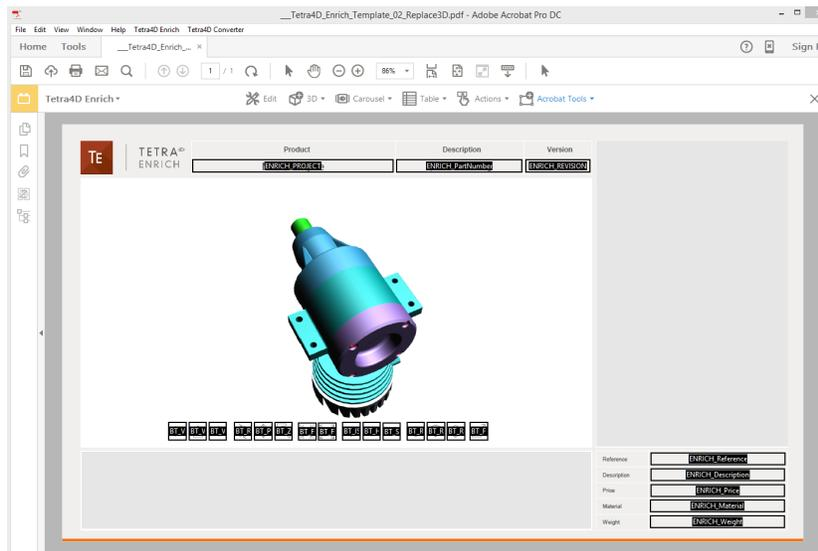

*Edit feature: highlight the text fields and buttons that can be modified
(Note that the Carousel of views and the table are temporarily hidden)*

Remark:

The “Edit object” feature temporarily hides any existing table, carousel or search widget to limit the number of visible objects (text fields and buttons).

Note that using the Select Object feature of the Prepare Form or the Reach Media tools of Acrobat keeps all the text fields and buttons that define the Tetra4D Enrich widgets visible.

Set populate method for text fields

The “Set populate method for text fields” function allows you to define how to populate text fields present in the PDF document, with information coming from:

- 3D File attributes,
- CAD model attributes,
- XML.

For example, it is possible to have a title block in the PDF document where different text fields are populated with information coming from the 3D CAD data that are in the document (name of the CAD file, attribute information like Material, Revision...)

Remark:

*This feature enables to directly populate the text fields with information present in the PDF document, and is also suitable for a template usage of the PDF document since the defined method to populate the text fields is stored in the PDF itself.
In case of re-use of an existing PDF document where this feature was used to define how to populate the text fields, the values present in these text fields will be automatically updated when a Replace 3D is performed.*

Definition of a methods to populate text fields

Remark:

*The text fields must be defined prior the definition of method to populate them.
Refer to [“Add text field”](#) for instructions on how to create text fields.*

1. Within the Tetra4D Enrich toolbar, choose Acrobat Tools > Set populate method for text fields.

Note: *The existing text fields in the active page of the PDF document are highlighted in orange.*

2. Select a text field.

Note: *Once selected, the text field is highlighted in blue.*

3. In the Populate method panel which appears on the right, select the source that will be used to populate the selected field.

Note: *Refer to [Description of the different methods to populate text fields](#) to have detailed explanations about the proposed methods.*

4. Depending on the selected source, select the attribute in the “Attributes list” sub-panel, or manually define the attribute name if not present in the list or the XML key in the “Attribute or XML key” sub-panel.
5. Click on the green check button “Save and populate fields” icon to populate the text field with the value and save the methods, or
6. Click on the red “X” “Cancel the modifications” icon to discard the changes.

Description of the “Set populate method for text fields” panel

The Editor panel offers several settings to define the populate method.

Hover your mouse over any of the buttons to see the specific command.

- **Select source:** Defines the method used to populate the text field.
- **Attribute or XML key:** Field that enable to manually define an attribute or an XML key.
- **Attribute list:** List of the attributes that are currently present if the 3D annotation, or list of the available File attributes.

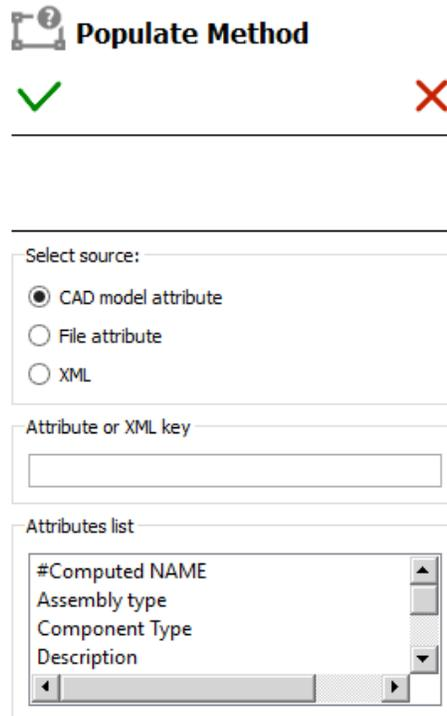

The screenshot shows the 'Populate Method' panel. At the top, there is a title bar with a question mark icon and the text 'Populate Method'. Below the title bar, there are two icons: a green checkmark on the left and a red 'X' on the right. The panel is divided into three sections by horizontal lines. The first section is titled 'Select source:' and contains three radio buttons: 'CAD model attribute' (which is selected), 'File attribute', and 'XML'. The second section is titled 'Attribute or XML key' and contains a text input field. The third section is titled 'Attributes list' and contains a list box with the following items: '#Computed NAME', 'Assembly type', 'Component Type', and 'Description'. The list box has a scrollbar on the right side.

Edit panel for the Set populate method for text fields

CAD model attributes

The text field is populated with the value of an attribute linked to the 3D annotation.

The list shows the attributes that are present in the 3D annotation.

Select source:

CAD model attribute
 File attribute
 XML

Attribute or XML key

Attributes list

- #Computed NAME
- Assembly type
- Component Type
- Description

Remark:

The text field is populated when the CAD model attribute is chosen and the “Save and populate fields” icon is pressed

Description
HOUSING FRONT

Text field populated with a CAD attribute

If the CAD attribute is not present in the list and defined manually using the Attribute or XML key, the text field will show the mapping key

Select source:

CAD model attribute
 File attribute
 XML

Attribute or XML key

MyAttribute

Attributes list

- #Computed NAME
- BodyID
- CV5FACENAME
- Description
- ItemNumber
- Material
- PartNumber
- Source

Description
[\$MODEL_PROP.MyAttribute\$]

This text field will be populated as soon as a Replace 3D operation will be performed on the document, if the chosen attribute exists in the read CAD data.

File attribute

The text field is populated with the selected 3D file's attribute.

- 3D file Name: Name of the file
- 3D file Name without extension: Name of the file without the extension
- 3D file Name with full path: Name of the file and full path
- 3D file Extension: Extension of file
- 3D file Creation date: Date of creation of the file
- 3D file Last modification date: Date of last modification
- 3D file size (Bytes): Size of the file in Bytes
- 3D file size (KB): Size of the file in Kilo Bytes
- 3D file size (MB): Size of the file in Mega Bytes

Select source:

CAD model attribute

File attribute

XML

Attribute or XML key

Attributes list

- 3D file Name
- 3D file Name without extension
- 3D file Name with full path
- 3D file Extension
- 3D file Creation date
- 3D file Last modification date
- 3D file size (Bytes)
- 3D file size (KB)
- 3D file size (MB)

Remark:

The text field is populated when the file attribute is chosen and the “Save and populate fields” icon is pressed

Product

housing front.CATPart

Text field populated with the name of the 3D file

If a Replace 3D operation is performed on the document, the text field will be updated with the chosen attribute corresponding to the read CAD data.

XML

The text field is populated with values defined in an XML file.

Note: Refer to [“Format of the XML file to import text field data”](#) for detailed explanations about the XML format and the mapping with the text fields.

The screenshot shows a user interface for selecting the source of XML data. It consists of three main sections:

- Select source:** A group box containing three radio buttons: "CAD model attribute", "File attribute", and "XML". The "XML" radio button is selected.
- Attribute or XML key:** A text input field that is currently empty.
- Attributes list:** A large, empty rectangular area intended for displaying a list of attributes.

Remark:

The XML keys are always defined manually. Consequently, the text field will show the mapping key when the “Save and populate fields” icon is pressed.

This screenshot shows the same interface as above, but with the "Attribute or XML key" field populated with the text "revision". To the right of this field, there is a vertical stack of two grey buttons:

- The top button is labeled "Version".
- The bottom button is labeled "[\$revision\$]".

Text field populated with a XML value

This text field will be populated as soon as a [Populate text fields from XML](#) operation will be performed.

Populate text fields from XML

The Populate text fields from XML function allows you to populate text fields in the PDF document from an XML file.

1. Prepare the PDF document by creating all the required text fields.

Note: Refer to [Add text field](#) for explanation about text fields.

Product	Description	Version
ENRICH_PROJECT	ENRICH_PartNumber	ENRICH_REVISION

Text fields in the PDF document

2. Define the method to populate these text fields to enable the mapping with the values defined in the XML file.

Note: Refer to [“Set populate method for text fields”](#) for detailed explanations about the definition of mapping keys with the text fields.

Product	Description	Version
[\$project\$]	[\$description\$]	[\$revision\$]

Example of mapping keys defined in the text fields

3. Within the Tetra4D Enrich toolbar, choose Acrobat Tools > Populate text fields with XML.

Note: Refer to [“Format of the XML file to import text field data”](#) for detailed explanations about the XML format and the mapping with the text fields.

4. Select the XML in the “XML File” dialog.
5. Check the result of the import in the text fields.

Product	Description	Version
Micro Engine	Spare Parts catalog	2016/02/29

Example of populated text fields with imported values

Remark:

The imported values are set as values for these populated text fields. However, the populate method remains assigned to the text fields so that it is possible to populate again these text fields with another XML file.

Format of the XML file for the Import text field data

The XML file contains all the required information to populate the text fields that are in the PDF document (key information and value).

The method to map the contents of the XML file to the text fields is based on key values that must be defined in the text fields using the [“Set populate method for text fields”](#) feature.

- Example of a XML file:

```
<Fields>
  <Field key="KeyValue1" value="Value1" />
  <Field key="KeyValue2" value="Value2" />
</Fields>
```

- Key for the mapping (in the XML file):

The values of the keys for the mapping are defined in the **“key”** attribute.

```
<Field key="KeyValue1" value="Value1" />
```

- Key for the mapping (in the text fields in the PDF document):

The mapping method must be defined using the [“Set populate method for text fields”](#) feature

Product
[\$Key_Value1\$]

- New attribute definition:

The values of the keys for the mapping are defined in the **“value”** attribute.

```
<Field key="KeyValue1" value="Value1" />
```

- Results after XML file import:

Product
Value1
